

PRODUCTS FOR METAL AND
INORGANIC ANALYSIS



35 years and many more to come!



Since 1979 Alpha Resources Inc. presence in the marketplace has helped control unjustified price increases and has caused price reductions by our competition.

Thanks to your growing support, Alpha Resources continues to enhance its service, maintain low pricing and expand its offering.

Our growing sales of the high quality affordably priced Eltra line of instruments gives you another useful avenue to avoid overpriced analyzers. In 19 years no Eltra analyzer has been left unsupported. We do not force you to routinely purchase unneeded new instruments because they are being prematurely rendered obsolete. We have HUNDREDS of satisfied users and we would like all of our customers to consider this money saving approach.

We wish to thank the thousands of you that have made our success possible. We truly appreciate every single one of you and pledge to continue expanding our products and provide you with an alternate source of **QUALITY PRODUCTS FOR ANALYSIS**.

Because of Alpha[®] your old LECO[®] unit may still be worth \$\$\$\$. Call Alpha[®] and see if this is the case for your old unit. Call us toll free and talk to one of our friendly salesmen. Your best option may well be a new Eltra with a supply credit, in any case, only a few minutes is all it will take. (800) 833-3038 Toll Free

Sincerely,
Alpha Resources Inc.



Alpha Resources is committed to total quality excellence and the continuing improvement of its operations to achieve both high quality and customer satisfaction.

Alpha Resources is pleased to have achieved ISO/IEC 17025 as well as ISO 9002. Our scope of accreditation covers the testing of all our certified reference materials and verifies our commitment to excellence through our quality system.

All Alpha Resources products will perform at the highest level without the high price

Terms of Sales/Ordering Information..... 3
 General Combustion/Inert Gas Fusion Supplies..... 4-5, 9-11
 LECO® CS744/844 Carbon Sulfur Quick Reference Guide..... 6
 LECO® CS230 Carbon Sulfur Quick Reference Guide..... 7
 Eltra CS800 Carbon and Sulfur Analyzer for Metals and Inorganics..... 8
 Graphite Crucibles and Electrode Inserts..... 10-11
 Electrode Insert Repair Service..... 12
 Capsules and Crucibles..... 10-12
 Furnace Cleaning Brushes and Brush Handles..... 13
 Eltra Oxygen, Hydrogen and Nitrogen Analyzer for Metals and Inorganics..... 14
 Combustion/Reaction Tubes and Glassware..... 15-17
 Certified Reference Materials, Standards..... 18-21
 Eltra CS2000 Carbon and Sulfur Analyzer for Organics AND Inorganics..... 22
 O-Rings..... 23-25
 Sample Preparation, Pin Tubes, Sampling Devices..... 26
 Useful Items..... 27
 Alpha® to LECO® Cross Reference..... 28-37
 Metallography..... 38

REFERENCE CARD: CS844 and CS744 SERIES
 CONSUMABLES & SUPPLIES

You can now place your order online—visit us at WWW.ALPHARESOURCE.COM
 download certs, MSDS, obtain pricing, stock status, find new products,
 cross references and much more

COMBUSTION SUPPLIES
 (528-018) AR3818 Ceramic crucibles in bags, box of 1000
 (528-050) AR3818B Ceramic crucibles in bags, box of 500
 (528-018) AR3818P Ceramic crucibles in a bag of 50
 AR3818F Ceramic crucibles, foil wrapped box of 1000
 (528-120) AR8120 Low sulfur crucibles, 150 crucibles
 (619-880) AR9880 Ceramic crucible cover, 10mm hole, box of 3000
 AR9880S Ceramic crucible cover, 10mm hole, bag of 250
 AR9880-100 Ceramic crucible cover, 10mm hole, bag of 100
 (528-040) AR040 Ceramic crucible cover, 4mm hole, box of 1000
 AR040S Ceramic crucible cover, 4mm hole, bag of 250
 (528-042) AR042 Porous crucible cover, box of 1000
 AR042S Porous crucible cover, bag of 250
 (772-381) AR2381 Lance cleaning wire
 (789-115) AR789 Lance tube
 (601-920) AR920 Silicone rubber O-ring
 (772-906) AR2906 Combustion tube support
 (782-880) AR2880 Vacuum cleaner filter
 (501-082) AR022 Wire cleaning brush

ACCELERATORS
 AR264 (501-264) Copper metal, 0.5lb bottle
 AR363 (501-363) Copper metal, 3lb bottle
 AR367 (501-640) Copper metal, 25lb can
 AR673 (502-231) High purity iron, 1lb bottle
 AR077 (501-077) Iron chip 2lb bottle
 AR027 (763-266) Alphasel tungsten 5lbs, -20 to +40 mesh
 AR027S (763-026) Alphasel tungsten 30lbs -20 to +40 mesh
 AR008 (501-008) Alphasel II tungsten 5lb
 AR008S (502-297) Alphasel II tungsten 30lbs
 AR173 (502-173) Alphasel II high purity tungsten, 750g
 AR266 (763-263) Alphasel tungsten, 5lbs, -12 to +20 mesh
 AR266B (763-027) Alphasel tungsten, 30lbs -12 to +20 mesh

REAGENT AND CATALYST TUBES
 (619-591-315) AR1315 Glass reagent tube
 (619-591-740) AR1740 Glass tube
 (619-590-122) AR012 Quartz tube
 (619-591-314) AR1314 Glass tube
 (619-590-409) AR0409 Quartz tube
 (619-591-683) AR683 Combustion Tube (Requires ARG83K Kit)

CATALYST AND REAGENTS
 (501-171-HA2) AR171 Anhydrous 1lb bottle
 (761-098) AR098 Cellulose 1lb package
 (502-174-HA2) AR2174 Alphasolve II 500g bottle, 20-30 mesh
 (501-176-HA2) AR2176 Alphasolve II 500g bottle, 8-20 mesh
 (501-587) AR1912 Platinum/silica 15g bottle
 (502-177) AR177 Quartz wool 50g package
 (501-170) AR170 Rare earth copper oxide 50g bottle

OPERATION ACCESSORIES
 (768-980) AR980 Balston filter
 (761-929) AR929 Crucible tongs
 (781-278) AR278 Crucible tray
 (775-306) ARS306 Secondary filter, 10 micron
 (501-241) AR241 Vacuum grease
 (771-354) AR354 Oscillator tube
 (776-129) AR129 Induction coil
 (619-591-970) AR1970 Brush

Alpha Resources Inc. Phone: 800-833-3083
 PO Box 3090 Johnson Rd Fax: 309-485-3029
 Riverdale, Md. 48127 Email: sales@alpharesources.com
WWW.ALPHARESOURCE.COM

Online Documentation

QUICK REFERENCE CARDS

Quickly find the correct Alpha part number for your OEM instrumentation.

MSDS's

Complete list of all related Material Safety Data Sheets

Certificates

All current and past Certifications of Analysis

Visit us at - www.alpharesources.com



Ordering Online Now Available

- 1) Visit www.alpharesource.com
- 2) Click Shop Online
- 3) Click NEW USER to register or enter your log in information



PHONE:
800-833-3083
Or
269-465-5559



EMAIL:
sales@alpharesources.com



FAX:
269-465-3629



MAIL:
Alpha Resources
3090 Johnson Rd PO 199
Stevensville, MI. 49127

Terms and Conditions

Ordering Online: You may visit our web page at www.alpharesources.com to place an order online. This is only available to current customers who have an established account with Alpha Resources. You will be able to issue a purchase order and get current pricing while placing the order.

Payment Terms: Alpha Resources has a \$25.00 minimum order requirement. Alpha Resources terms are Net 30 with approved credit. New customers will need to submit credit references when they place their first order to be set up on Net 30. We accept Visa, MasterCard or American Express.

Shipping Method: FOB shipping point is Stevensville, MI. Alpha Resources is pleased to offer UPS shipping. We will attempt to ship all orders within a period of 5 business days of the date the order is received. If you would like to use any other shipping company, you will need to provide us with your account number.

Disclaimer: Alpha Products are intended for use in a laboratory environment. They are not intended for use in home or other applications. It is the customer's responsibility to store, handle, properly use and dispose of all products purchased from Alpha Resources Inc. Our prices are subject to change without notice. Customer should contact Alpha or visit our website to obtain current pricing.

MSDS: Material Safety Data Sheets are available on our website or by contacting us directly.

Reagents for LECO®, Bruker, Horiba and Eltra

ALPHA®	LECO®	Description	Contents
AR171	501-171-HAZ	AlphaDri – Anhydrone for H ₂ O absorption	1 lb. (454 g)
AR098	764-098	Cellulose – Trap for SO ₃	1 lb. (454 g)
AEB1002	502-190	Copper Oxide Wire – converting CO to CO ₂ and H ₂ to H ₂ O	100 g
AR189	502-189	Copper Sticks – removal of O from inert carrier gas	100 g ampule
AR2304	502-304	Copper Sticks – removal of O from inert carrier gas	100 g
AR2304-500	502-304-500	Copper Sticks – removal of O from inert carrier gas	500 g
AR621	501-621	Copper Turnings	100 g
AR177	502-177	Fine Quartz Wool	50g
AR2156	502-156	Fluorhib	1 lb. (454 g)
AR081	501-081	Glass Wool – packing material for reagent tubes	1 lb. (454 g)
AR073	501-073	Graphite Powder	100 g
AR351	502-351	Halogen Scrubber	50 g
AR608	769-608-HAZ	Halogen Trap Reagent	200 g
AR610	769-610	Halogen Trap Reagent	225 g
AR2176	502-176-HAZ	AlphaSolve II – for CO ₂ removal	500g
AR2174	502-174-HAZ	AlphaSolve II – for CO ₂ removal	500g
AR060	501-060	Manganese Dioxide – SO ₂ scrubber	60 g
AR912	501-587	Platinized Silica – converting CO to CO ₂	15 g
AR170	501-170	Rare Earth Copper Oxide - converting CO to CO ₂ and H ₂ to H ₂ O	100 g
AR611	761-747-HAZ	Schutze Reagent - converting CO to CO ₂	500 g

Accelerators/Fluxes for LECO®, Bruker, Horiba and Eltra

ALPHA®	LECO®	Description	Contents
AR264	501-264	Copper Accelerator	0.5 lb. (227g)
AR263	501-263	Copper Chip Accelerator (-20 +30 mesh)	3 lb. (1.36 kg)
AR366	501-640	Copper Chip Accelerator (-20 +30 mesh)	20 lb. (9 kg)
AR077	501-077	Iron Chip – standard grade (-6 +20 mesh)	2 lb. (908g)
AR467	763-467	Iron Chip – standard grade (-6 +20 mesh)	30 lb. (13.6kg)
AR673	502-231	HP Iron Chip – High Purity (-6 +20 mesh)	1 lb. (454 g)
AR027	763-266	Alphacell® III – tungsten (-20 +40 mesh)	5 lb. (2.27kg)
AR027B	763-026	Alphacell® III – tungsten (-20 +40 mesh)	30 lb. (13.6kg)
AR008	501-008	Alphacell® II – tungsten/tin blend (-20 +40 mesh)	5 lb. (2.27kg)
AR008B	502-297	Alphacell® II – tungsten/tin blend (-20 +40 mesh)	30 lb. (13.6kg)
AR173	502-173	Alphacell® II – tungsten/tin blend high purity (-20 +40 mesh)	1.7 lb. (750g)
AR266	763-263	Alphacell® – tungsten (-12 +20 mesh)	5 lb. (2.27kg)
AR266B	763-027	Alphacell® – tungsten (-12 +20 mesh)	30 lb. (13.6kg)
AR598	501-598	Nibbled Nickel Flux	100 g
AR2344	502-344	Ultra High Purity Nickel Basket 1 gram	100/bottle
AR2345	502-345	Ultra High Purity Nickel Basket 1.5 gram	100/bottle
AR568	502-822	Nickel Capsule	100/bottle
AR059	501-059	Tin Capsules	100/bottle
AR076	501-076	Tin Metal Accelerator (-20 +30 mesh)	2 lb. (908 g)
AR695	762-695	Tin Metal Accelerator (-20 +30 mesh)	25 lb. (11.35kg)
AR639	761-739	Tin Flux – for H/N/O determinations (0.5 g pellets)	1 lb. (454 g)

All LECO®, Bruker, Horiba and Eltra Carbon and Sulfur Determinators

ALPHA®	LECO®	Description	Contents
AR3818	528-018	Ceramic Crucible Bagged – for carbon/sulfur analysis	1000/box
AR3818F	528-018	Ceramic Crucible Foil wrap – for carbon/sulfur analysis	1000/box
AR8028	528-028	Standard Filtering Crucible	100/box
AR8028B	528-028-500	Standard Filtering Crucible	500/box
AR8030	528-030	Filtering Crucible – for graphitic carbon determinations	100/box
AR040	528-040	Crucible Cover – 4mm hole	1000/box
AR042	528-042	Porous Crucible Cover	1000/box
AR3818B	528-050	Ceramic Crucible Bagged – for carbon/sulfur analysis	500/box
AR9880	619-880	Crucible Cover – 10mm hole	1000/box
AR9880-100	619-880-100	Crucible Cover – 10mm hole	100/box

What our customers say:

“Service is always fast and courteous. I LOVE YOUR WEBSITE!!! So easy to maneuver and order!!!”
 Betty – Houston – Commercial Lab

**DO YOU OWN A CS744/844?
 SAVE THOUSANDS!!!**

Another Money Saving Product from Alpha Resources

Alpha has created a new Combustion Tube (AR683) and Replacement Kit (AR683K) for the LECO® CS844/744 Combustion tube (619-591-683)

Our combustion tube is priced at **half of what you are currently paying!** Also realize additional quantity discounts available, and Alpha will provide the Replacement kit to you at no charge with the purchase of 12 Alpha Combustion Tubes (AR683)

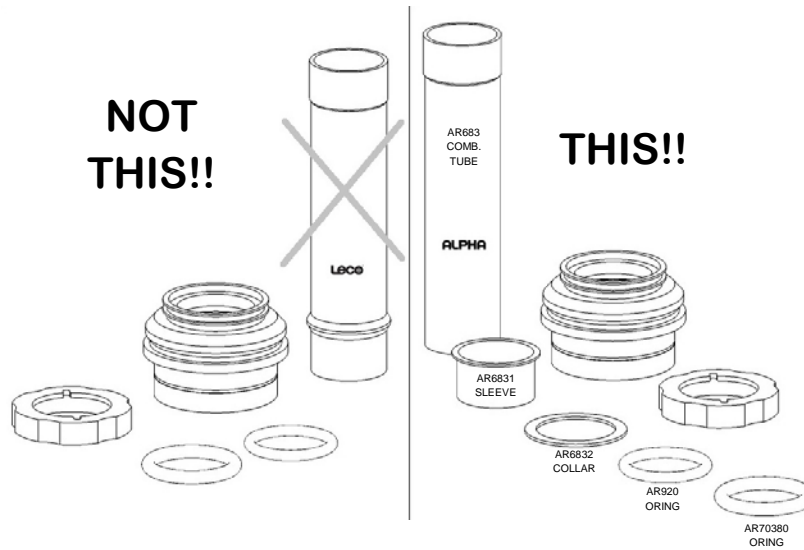

Visit: www.alpharesources.com

Alpha has a video online that shows the use of our simple to use replacement kit

This kit and simple style combustion tube WILL save you thousands over the life of your analyzer.

Our replacement kit (AR683K) will save you the following:

1. Saves time because the lower O-Ring needn't be removed during replacement.
2. More precise vertical alignment.
3. Tube remains in Lower Tube Ring during multiple cleanings or until replaced.
4. Easily installed and can quickly be returned to original configuration.
5. Can save you thousands of \$\$\$ over the life of the CS844/744.

LECO® CS844 AND CS744 SERIES CARBON AND SUFLUR ANALYZER

FOR OLDER MODELS PLEASE
VISIT
WWW.ALPHARESOURCES.COM

COMBUSTION SUPPLIES

- (528-018) AR3818 Ceramic crucibles in bags, box of 1000
- (528-050) AR3818B Ceramic crucibles in bags, box of 500
- (528-018) AR3818P Ceramic crucibles in a bag of 50
- AR3818F Ceramic crucibles, foil wrapped box of 1000
- (528-120) AR8120 Low sulfur crucibles, 150 crucibles
- (619-880) AR9880 Ceramic crucible cover, 10mm hole, box of 1000
- AR9880S Ceramic crucible cover, 10mm hole, bag of 250
- AR9880-100 Ceramic crucible cover, 10mm hole, bag of 100
- (528-040) AR040 Ceramic crucible cover, 4mm hole, box of 1000
- AR040S Ceramic crucible cover, 4mm hole, bag of 250
- (528-042) AR042 Porous crucible cover, box of 1000
- AR042S Porous crucible cover, bag of 250
- (772-381) AR2381 Lance cleaning wire
- (773-316) AR789 Lance tube
- (601-920) AR920 Silicone rubber O-ring
- (772-906) AR2906 Combustion tube support
- (782-880) AR2880 Vacuum cleaner filter
- (501-082) AR022 Wire cleaning brush

ACCELERATORS

- AR264 (501-264) Copper metal, 0.5lb bottle
- AR263 (501-263) Copper metal, 3lb bottle
- AR366 (501-640) Copper metal, 25lb can
- AR673 (501-673) High purity iron, 1lb bottle
- AR077 (501-077) Iron chip 2lb bottle
- AR027 (763-266) Alphacel tungsten 5lbs, -20 to +40 mesh
- AR027B (763-026) Alphacel tungsten 30lbs -20 to +40 mesh
- AR008 (501-008) Alphacel II tungsten 5lb
- AR008B (502-297) Alphacel II tungsten 30lbs
- AR173 (502-173) Alphacel II high purity tungsten, 750g
- AR266 (763-263) Alphacel tungsten, 5lbs, -12 to +20 mesh
- AR266B (763-027) Alphacel tungsten, 30lbs -12 to +20 mesh

REAGENT AND CATALYST TUBES

- (619-591-315) AR1315 Glass reagent tube
- (619-591-740) AR1740 Glass tube
- (619-590-412) AR0412 Quartz tube
- (619-591-314) AR1314 Glass tube
- (619-590-409) AR0409 Quartz tube
- (619-591-683) AR683 Combustion tube (Requires AR683K Kit)

CATALYST AND REAGENTS

- (501-171-HAZ) AR171 Anhydrone 1lb bottle
- (764-098) AR098 Cellulose 1lb package
- (502-174-HAZ) AR2174 Alphasolve II 500g bottle, 20-30 mesh
- (502-176-HAZ) AR2176 Alphasolve II 500g bottle, 8-20 mesh
- (501-587) AR912 Platinum/silica 15g bottle
- (502-177) AR177 Quartz wool 50g package
- (501-170) AR170 Rare earth copper oxide 50g bottle

- (760-138) AR138 Sample tweezers

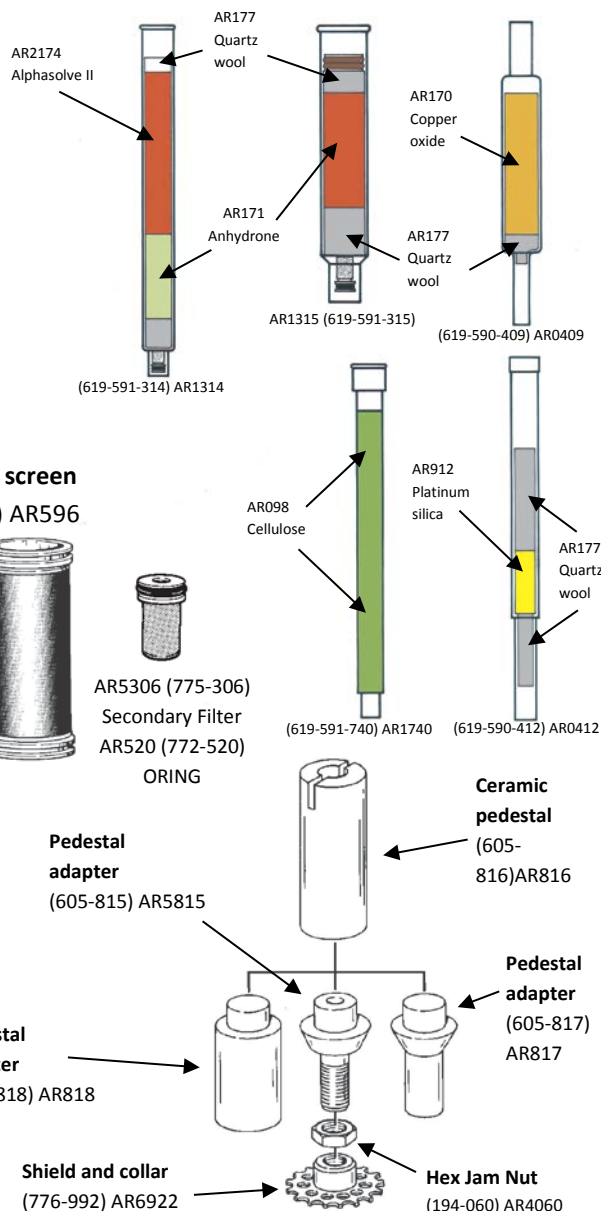

OPERATION ACCESSORIES

- (768-980) AR980 Balston filter
- (761-929) AR929 Crucible tongs
- (781-273) AR028 Crucible tray
- (775-306) AR5306 Secondary filter, 10 micron
- (501-241) AR241 Vacuum grease
- (771-354) AR354 Oscillator tube
- (776-129) AR129 Induction coil
- (619-591-970) AR1970 Brush

LECO® CS-230 SERIES CARBON AND SULFUR ANALYZER

FOR OLDER MODELS PLEASE
VISIT
WWW.ALPHARESOURCES.COM

COMBUSTION SUPPLIES

- (528-018) AR3818 Ceramic crucibles in bags, box of 1000
- (528-050) AR3818B Ceramic crucibles in bags, box of 500
- (528-018) AR3818P Ceramic crucibles in a bag of 50
- AR3818F Ceramic crucibles, foil wrapped box of 1000
- (528-120) AR8120 Low sulfur crucibles, 150 crucibles
- (619-880) AR9880 Ceramic crucible cover, 10mm hole, box of 1000
- AR9880S Ceramic crucible cover, 10mm hole, bag of 250
- AR9880-100 Ceramic crucible cover, 10mm hole, bag of 100
- (528-040) AR040 Ceramic crucible cover, 4mm hole, box of 1000
- AR040S Ceramic crucible cover, 4mm hole, bag of 250
- (528-042) AR042 Porous crucible cover, box of 1000
- AR042S Porous crucible cover, bag of 250

(772-381) AR2381 Lance cleaning wire

(773-316) AR789 Lance tube

(601-920) AR920 Silicone rubber Oring

(772-906) AR2906 Combustion tube support

(782-880) AR2880 Vacuum cleaner filter

(501-082) AR022 Wire cleaning brush

ACCELERATORS

- (501-264) AR264 Copper metal, 0.5lb bottle
- (501-263) AR263 Copper metal, 3lb bottle
- (501-640) AR366 Copper metal, 25lb can
- (501-673) AR673 High purity iron, 1lb bottle
- (501-077) AR077 Iron chip 2lb bottle
- (763-266) AR027 Alphacel tungsten 5lbs, -20 to +40 mesh
- (763-026) AR027B Alphacel tungsten 30lbs -20 to +40 mesh
- (501-008) AR008 Alphacel II tungsten 5lb
- (502-297) AR008B Alphacel II tungsten 30lbs
- (502-173) AR173 Alphacel II high purity tungsten, 750g
- (763-263) AR266 Alphacel tungsten, 5lbs, -12 to +20 mesh
- (763-027) AR266B Alphacel tungsten, 30lbs -12 to +20 mesh

REAGENT AND CATALYST TUBES

- (772-739) AR544 Glass catalyst heater tube
- (601-390) AR390 Glass tube
- (771-030) AR030 Glass tube
- (771-373) AR373 Glass reagent tube



CATALYST AND REAGENTS

- (501-171-HAZ) AR171 Anhydrone 1lb bottle
- (761-098) AR098 Cellulose 1lb package
- (502-174-HAZ) AR2174 Alphasolve II 500g bottle, 20-30 mesh
- (502-176-HAZ) AR2176 Alphasolve II 500g bottle, 8-20 mesh
- (501-587) AR912 Platinum/silica 15g bottle
- (502-177) AR177 Quartz wool 50g package
- (501-170) AR170 Rare earth copper oxide 50g bottle

(760-138) AR138 Sample tweezers



Combustion tube
(772-905) AR057



SST Filter screen
(773-311) AR311

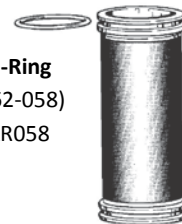

O-Ring
(762-058)
AR058

AR5306 (775-306)
Secondary Filter
AR520 (772-520)
ORING

Ceramic pedestal
(605-816)
AR816



Pedestal adapter
(605-818) AR818

Pedestal adapter
(605-817)
AR817

Pedestal adapter
(605-815) AR5815

Shield and collar
(776-992) AR6922

Hex jam nut
(194-060) AR4060

Regular glass scoop (503-032) AR901
volume 0.14cc



Scoop for tungsten (767-542) AR542
volume 0.1cc



Metal scoop (773-579) AR579
volume 0.18cc



Reagent tube glass funnel
(502-023)
AR473

OPERATION ACCESSORIES

- (768-980) AR980 Balston filter
- (761-929) AR929 Crucible tongs
- (781-273) AR028 Crucible tray
- (775-306) AR5306 Secondary filter, 10 micron
- (501-241) AR241 Vacuum grease
- (771-354) AR354 Oscillator tube
- (776-129) AR129 Induction coil
- (604-163) AR163 Brush
- (610-735) AR735 Brush
- (773-561) AR561 Brush



CS800 Carbon and Sulfur Analyzer

Another high quality product at an affordable price brought to you by
Alpha Resources Inc.



What our customers say:

“Our CS800 has not given us a problem since purchasing it. Extremely reliable and you can’t beat the price”

Dave – Indiana – Steel Industry

• Extremely Reliable	• Extremely Affordable
• Precise and Quick Measurements	• Automated Furnace Cleaning
• Minimal Maintenance Required	• Filters and Reagents Easily Accessed
• Up to four independent IR cells	• Powerful 2.2K Induction Furnace
• Autoloader Available (36 and 130 pos)	• Robust Design

The CS-800 by ELTRA provides the speed and accuracy required for today’s stringent demands. Carbon and Sulfur are simultaneously determined in about 50 seconds. The unit comes complete with computer, monitor, printer and interfaced 4th place balance.

Because of Alpha[®] your old LECO[®] unit may still be worth \$\$\$\$. Call Alpha[®] and see if this is the case for your old unit. Call us toll free and talk to one of our friendly salesmen. Your best option may well be a new Eltra with a supply credit, in any case, only a few minutes is all it will take. Call Alpha TODAY toll Free (800) 833-3038

For RC-412/RC-612

ALPHA®	LECO®	Description	Contents
AR1335	781-335	Quartz Boat	1/pkg
AR2059	782-059	Nickel Liner	10/pkg

For RH-404/RH-404EN/RH-402 – Hydrogen Analysis

ALPHA®	LECO®	Description	Contents
AR059	501-059	Small Tin Capsule	100/bottle
AR2166	502-040	Large Tin Capsule	100/bottle
AR710	603-710	Quartz Crucible for hot extraction analysis	24/pkg
AR331S	764-330	Graphite Crucible (RH-404EN)	1000/pkg
AR9520	769-520	Short Graphite Crucible (RH-402)	1000/pkg
AR761	769-761	Tall Graphite Crucible (RH-402)	100/pkg
AR782P	782-719	High Temp Graphite Crucible (RH-404)	50/pkg
AR213	763-213	Graphite Crucible – RH-1E	1000/box
AR7827	780-720	High Temp Graphite Crucible (RH-404)	1000/pkg
AR872HD	782-720SHD	High Density Graphite Crucible (RH-404)	1000/pkg
AR721	782-721	Low Electrode Tip for all 782 Crucibles	1/pkg

For Horiba Analyzers

ALPHA®	HORIBA No.	Description	Contents
AR1533	905.200.010.000	Outer Graphite Crucible	1000/box
AR200010	905.200.010.001	Graphite Crucible	1000/box
AR200020	905.200.020.001	Graphite Crucible	1000/box
AR79001	905.201.790.001	Graphite Crucible	1000/box
AR1534		Outer Graphite Crucible	1000/box
AR1535		Inner Graphite Crucible used with AR1534	1000/box

For all Eltra Inert Gas Fusion Analyzers ON900, OH900, OHN2000

ALPHA®	ELTRA No.	Description	Contents
AR6247	90190	Graphite Crucible	1000/box
AR5431	90180	Graphite Crucible	1000/box
AR433	90185	Graphite Crucible	1000/box
AR31360	31360	Graphite Electrode Tip	1/pkg
AR31250	31250	Upper Electrode	1/pkg

For Bruker Oxygen, Nitrogen, Hydrogen Analyzers

ALPHA®	BRUKER No.	Description	Contents
AR8762	S30923600	Graphite Crucible	1000/box
AR8762C	S30923600	Graphite Crucible	100/bag
AR2280		Graphite Crucible Base	10/pkg

**Inert Gas Fusion Supplies for Oxygen, Nitrogen, Hydrogen Determinations.
Includes LECO® TC136, TC300, TC400, RO416, TC436, TC500, TC600, OHN836**

ALPHA®	LECO®	Description	Contents
AR059	501-059	Small Tin Capsule	100/bottle
AR2166	502-040	Large Tin Capsule	100/bottle
AR568	502-822	Nickel Capsule	100/bottle
AR376	618-376	Electrode Tip	1/pkg
AR691	611-351-182	Electrode Tip for 776-247 crucible	1/pkg
AR619	619-895	Graphite Crucible, High Temp	1000/box
AR331S	764-330	Graphite Crucible	1000/box
AR5431	775-431	Inner Graphite Crucible - used with AR433	1000/box
AR433	775-433	Outer Graphite Crucible – used with AR5431	50/pkg
AR431P	775-892	Inner Graphite Crucible – used with AR433	100/pkg
AR6247	776-247	Graphite Crucible – typical for nitrogen/oxygen analysis	1000/box
AR053HD	776-247	High Temp Graphite Crucible – used of high temp applications	1000/box
AR7808	780-890	Large ID Crucibles – typically used for oxygen with covers	1000/box
AR0892	780-892	Graphite Crucible Covers	1000/box
AR782P	782-719	High Temp Graphite Crucible (RH-404)	50/pkg
AR7827	780-720	High Temp Graphite Crucible (RH-404)	1000/pkg
AR872HD	782-720SHD	High Density Graphite Crucible (RH-404)	1000/pkg
AR721	782-721	Low Electrode Tip for all 782 Crucibles	1/pkg
AR2795	782-795HD	Inner Crucible – used with Ar2703	1000/box
AR2703	782-703	High Purity Outer Crucible – Used with AR2795	1000/pkg
AR2703	782-703-100	High Purity Outer Crucible – Used with AR2795	100/pkg

Electrode Inserts

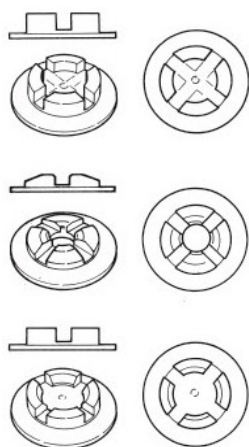

AR721 (782-721)
Hi-Temp
electrode insert
used with
AR7827

AR691 (774-691)
(611-351-181)
(611-351-182)
Standard
electrode insert

AR376 (618-376)
Electrode Insert
for TC-500,600

Alpha® has an improved process for removing and installing a new contact in the Upper Electrode Insert for NEW LECO® Models 620-976 and 619-926. This process provides you with a virtually new upper electrode. Why throw money away when you can simply return your defective electrode inserts to Alpha for expert renovation. Contact Alpha to find out more about this money saving item.

AR3930 Upper
Electrode Repair
(620-976) (619-926)

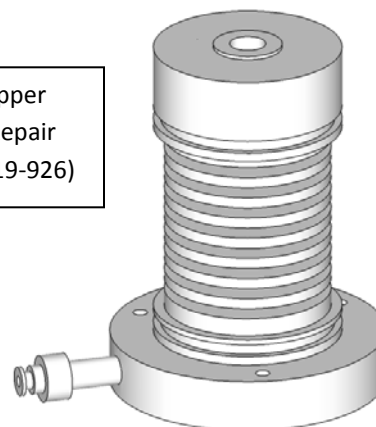

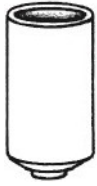

AR6247 or Ar053HD
(776-247)
(90190)



AR7827 or AR872HD
(782-720)
(782-720SHD)



AR5431
(775-431)
(90180)



AR433
(775-433)
(90185)

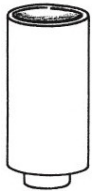

AR331S
(764-330)

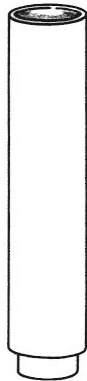

AR761
(769-761)



AR9520
(769-520)



AR7808
(780-890)

Ar0892
(780-892)



AR710
(603-710)



AR213
(763-213)



AR2795
(782-795HD)



AR277
(767-277)

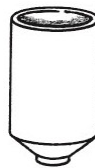

AR2703
(782-703)



AR79001
(905.201.790.001)



AR1533
(905.200.010.000)



AR3818
(528-018)
(90148)
Bagged
Ceramic
Crucibles



AR3818F
(528-018)
(90149)
Foil Wrapped
Ceramic
Crucibles

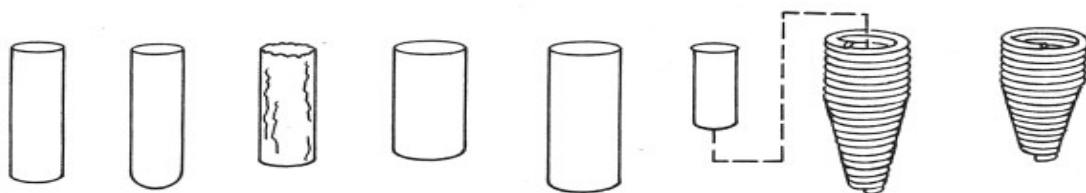

AR059F AR059 AND3500 AR2183 AR568 AR569 AR2345 AR2344

ALPHA®	LECO®	TYPE	METAL	DIAM.	HEIGHT	WEIGHT	#
AR059	501-059	Capsule	SN	5.0MM	18.0MM	160MG	100
AR059F		Capsule, flat bottom	SN	5.0MM	18.0MM	160MG	100
AR825	502-825	Capsule, flat bottom	SN	9.0MM	21.0mm	450MG	
AND3500		Pressed capsule	NI	5.0MM	12.5MM	65MG	100
AR2344	502-344	Basket (small)	NI	7.0M	12.0MM	1.0G	100
AR2345	502-345	Basket (large)	NI	7.0MM	17.0MM	1.5G	100
AR568	502-820/822	Smooth capsule	NI	6.5-7.0MM	12-14.5MM	500MG	100
AR569		Smooth capsule	NI	4.5MM	9.7MM	270MG	100
AR2183	502-183	Smooth capsule	NI	6.5MM	10.0MM	467MG	100

Electrode Repair Service

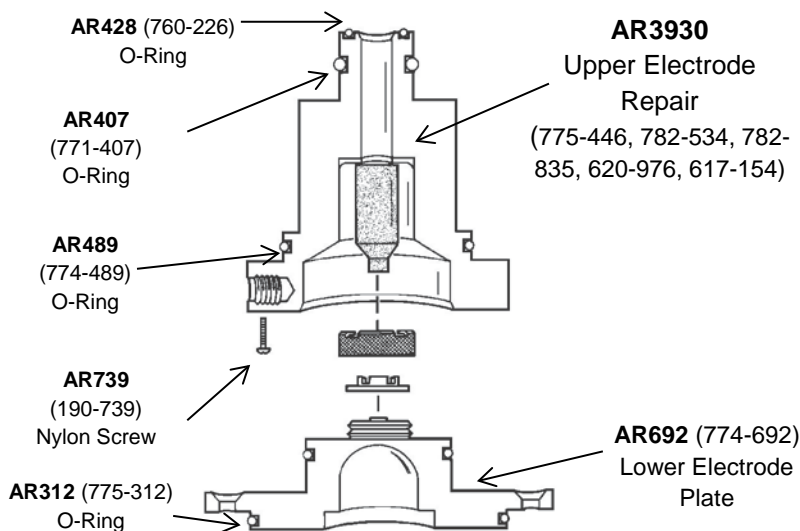

Alpha® has an improved process for removing and installing a new contact in the Upper Electrode Insert for Older LECO® Models 775-446, 782-534, 782-835, 620-976 and 617-154. This process provides you with a virtually new upper electrode. Why throw money away when you can simply return your defective electrode inserts to Alpha for expert renovation. Contact Alpha to find out more about this money saving item.

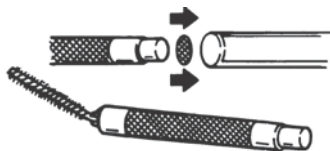

Alpha's brush handles are heavily knurled to ensure a firmer grip. This prevents slipping and allows the operator greater ease in cleaning the furnace electrode. The end of the handle has been specially machined to be used as a filter insertion tool for filter papers and metal screens.



AR697(762-697)
LARGE THROAT BRUSH
AR697H (762-823)
HANDLE ONLY



AR293 (760-293)(775-416)
SMALL THROAT BRUSH
AR293H (761-383)(775-416)
KNURLED HANDLE ONLY

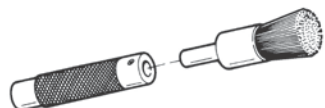

AR652(774-652) CLEANING BRUSH
AR652H BRUSH HANDLE ONLY
AR653(774-649)
CLEANING BRUSH WITH HANDLE



AR022B(760-144) CLEANING BRUSH – Alpha's bent brush has a generous supply of bristles

AR877(782-877) TRIM STEP BRUSH
For electrode cleaning. Used on TC-436 and others.



AR877H(782-918) BRUSH HANDLE ONLY. For trim step brush



AR938H(782-942) BRUSH HANDLE
For composite brush below



AR938(782-938) COMPOSITE BRUSH. Stainless steel outer bristles with inner brass brush for electrode cleaning

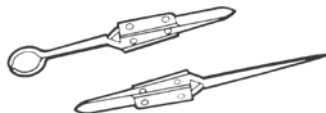

AR138(760-138) TWEEZERS
Deluxe stainless specimen tweezers. Super heavy duty, self-locking, straight style for secure handling of standards or specimens.

AR766(766-053) TWEEZERS
Curved tweezers for graphite crucibles.

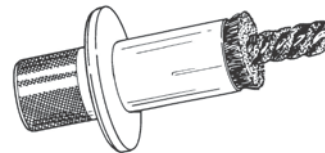

AR3302H (783-302)
BRUSH HANDLE ONLY
For use with AR3302 composite brush



AR3302 (783-302)
UPPER ELECTRODE BRUSH
For EF400/500/600/836 electrode furnaces. Used for cleaning upper electrode contact and bore areas.

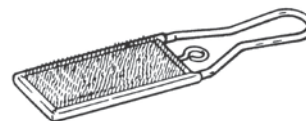

AR235 FILE CLEANER
This handy device makes it easy to keep files clean and cutting efficiently. Use when your file becomes loaded up with soft metal and other materials



AR234 (501-234)
SPECIMEN FILE
Ideally suited for oxygen specimen preparation. Tungsten carbide file for faster, cooler removal of surface scale. A convenient handle and knob for positive control and user comfort.



ON900, OH900 AND OHN2000

**Oxygen/Nitrogen, Oxygen/Hydrogen or Oxygen/Hydrogen/Nitrogen
all in one**



**Another high quality product at an affordable price brought to you by
Alpha Resources Inc.**

• Extremely Reliable	• Extremely Affordable
• Precise and Quick Measurements	• Ramping Fractional Analysis
• Minimal Maintenance Required	• Filters and Reagents Easily Accessed
• Long Term Stability	• Powerful 8K watt Impulse Furnace
• Granular Samples No Capsules Required	• Energy Efficient Graphite Tip

The ON900/OH900/OHN2000 by ELTRA provides the speed and accuracy required for today's stringent demands. The unit comes complete with computer, monitor, printer and interfaced 4th place balance.

Because of Alpha[®] your old LECO[®] unit may still be worth \$\$\$\$. Call Alpha[®] and see if this is the case for your old unit. Call us toll free and talk to one of our friendly salesmen. Your best option may well be a new Eltra with a supply credit, in any case, only a few minutes is all it will take. (800) 833-3038 Toll Free

Carbon/ Sulfur Analyzers LECO® and ELTRA

LECO® CS-200/CS-230/CS-300/CS-400

ALPHA®	LECO® No.	Description
AR390	601-390	Reagent Tube (Glass)
AR030	771-030	Filter Tube/Reagent Tube (Glass)
AR373	771-373	Reagent Tube (Glass)
AR544	772-739	Catalyst Heater Tube (Glass)
AR057	772-905	Combustion Tube (Quartz)

LECO® CS-444/CS-444LS/IR-412/IR-432

ALPHA®	LECO® No.	Description
AR604	604-112	Catalyst Tube (Quartz)
AR047	761-047	Reagent Tube (Glass)
AR030	771-030	Filter Tube/Reagent Tube (Glass)
AR373	771-373	Reagent Tube (Glass)
AR544	772-739	Catalyst Heater Tube (Glass)
AR057	772-905	Combustion Tube (Quartz)

LECO® CS-600/C-600/S-600

ALPHA®	LECO® No.	Description
AR390	601-390	Reagent Tube (Glass)
AR604	604-112	Catalyst Tube (Quartz)
AR603	618-603	Catalyst Tube (Quartz)
AR030	771-030	Filter Tube/Reagent Tube (Glass)
AR373	771-373	Reagent Tube (Glass)
AR544	772-739	Catalyst Heater Tube (Glass)
AR057	772-905	Combustion Tube (Quartz)

LECO® CS-844/CS-744

ALPHA®	LECO® No.	Description
AR0409	619-590-409	Incoming Catalyst Tube (Quartz)
AR0412	619-590-412	Measure Catalyst Tube (Quartz)
AR1314	619-591-314	Incoming Reagent Tube (Glass)
AR1315	619-591-315	Furnace Reagent Tube (Glass)
AR1740	619-591-740	Measure Reagent Tube (Glass)
AR683	619-591-683	Combustion Tube (Quartz)(Requires AR683K Kit)

LECO® RC-412

ALPHA®	LECO® No.	Description
AR373	771-373	Reagent Tube (Glass)
AR2428	782-428	Catalyst Tube (Quartz)
AR2038	783-299	Reaction Tube (Quartz)

LECO® RC-612

ALPHA®	LECO® No.	Description
AR7548	617-548	Reagent Tube
AR5125	625-505-125	Catalyst Heater Tube Rear (Quartz)
AR5104	625-510-402	Reaction Tube (Quartz)
AR9412	789-412	Catalyst Heater Tube (Quartz)

ELTRA CS800/CS2000

ALPHA®	ELTRA No.	Description
AR11062	11062	Reagent Tube
AR11064	11064	Reagent Tube
AR20040	20040	Catalyst Heater Tube
AR14130	14130	Combustion tube
AR09090	09090	Reagent Tube

LECO® DH-103/DH-603

ALPHA®	LECO® No.	Description
AR601	775-601	Reagent Tube (Glass)
AR7548	617-548	Reagent Tube (Glass)
AR9412	789-412	Reagent Tube (Glass)

LECO® RH-402

ALPHA®	LECO® No.	Description
AR4241	604-241	Reaction Tube (Quartz)
AR601	775-601	Reagent Tube (Glass)

LECO® RH-404/RH-404EN

ALPHA®	LECO® No.	Description
AR047	761-047	Reagent Tube (Glass)
AR601	775-601	Reagent Tube (Glass)

LECO® RHEN-600/602

ALPHA®	LECO® No.	Description
AR7548	617-548	Reagent Tube (Glass)
AR9412	789-412	Reagent Tube (Glass)

LECO® OHN-836/ON-836/OH-836/NH-836/O-836/N-836/H-836

Part No.	LECO® No.	Description
AR7716	617-716	Furnace Reagent Tube (Glass)
AR1314	619-591-314	Incoming Reagent Tube (Glass)

LECO® TC-436/TN-414/RO-416

ALPHA®	LECO® No.	Description
AR047	761-047	Reagent Tube (Glass)
AR373	771-373	Reagent Tube (Glass)
AR355	775-355	Catalyst Heater Tube (Glass)
AR601	775-601	Reagent Tube (Glass)

LECO® TCH-600/ROH-600/RH-600/TC-500/RO-500/TC-400/RO-400

ALPHA®	LECO® No.	Description
AR7548	617-548	Reagent Tube (Glass)
AR7716	617-716	Furnace Reagent Tube (Glass)
AR8809	618-809	Filter Tube
AR9412	789-412	Reagent Tube (Glass)

ELTRA OHN2000/ON900/OH900

ALPHA®	ELTRA No.	Description
AR11062	11062	Reagent Tube (Glass)
AR11064	11064	Reagent Tube (Glass)
AR20040	20040	Catalyst Tube (Quartz)

Alpha Resources is proud to be ISO 17025 Accredited and Guide 34

Standard are typical. Please contact Alpha Resources or visit our website for current values.

CARBON AND HYDROGEN IN TITANIUM STANDARD

<u>PART #</u>	<u>% CARBON</u>	<u>% HYDROGEN</u>	<u>SAMPLE SIZE</u>	<u>WEIGHT</u>
AR588	0.008	0.0137	250mg	250g
AR589	0.012	0.0192	250mg	250g

CARBON / SULFUR RING STANDARDS

<u>PART #</u>	<u>SIZE</u>	<u>% CARBON</u>	<u>% SULFUR</u>	<u>WEIGHT</u>
AR869	1g	0.019	0.014	454g
AR870	1g	0.032	0.033	454g
AR871	1g	0.051	0.034	454g
AR872	1g	0.180	0.019	454g
AR873	1g	0.468	0.0109	454g
AR874	1g	0.723	0.022	454g
AR875	1g	0.827	0.0066	454g
AR876	1g	0.546	0.0082	454g
AR878	1g	0.271	0.019	454g

CARBON / SULFUR PIN STANDARDS

<u>PART #</u>	<u>SIZE</u>	<u>% CARBON</u>	<u>% SULFUR</u>	<u>WEIGHT</u>
AR510	0.5g	2.41	0.091	250g
AR511	0.5g	0.083	0.238	250g
AR512	0.5g	0.015	0.262	250g
AR881	1g	0.016	0.0019	454g
AR882	1g	0.064	0.0229	454g
AR883	1g	0.19	0.022	454g
AR884	1g	0.4410	0.0110	454g
AR885	1g	0.810	0.0076	454g
AR886	1g	0.738	0.024	454g
AR888	1g	0.082	0.243	454g
AR889	1g	1.06	0.0213	454g
AR890	1g	0.099	0.0182	454g
AR891	1g	0.038	0.033	454g
AR892	1g	0.0051	0.0024	454g
AR893	1g	1.50	0.013	454g
AR894	1g	0.544	0.0096	454g
AR895	1g	0.247	0.021	454g
AR896	1g	0.168	0.087	454g

TUNGSTEN CARBIDE STANDARD

<u>PART #</u>	<u>% CARBON</u>	<u>% SULFUR</u>	<u>WEIGHT</u>
AR307	6.15	0.0041	100g

Alpha Resources is proud to be ISO 17025 Accredited and Guide 34

Standard are typical. Please contact Alpha Resources or visit our website for current values.

CARBON / SULFUR / NITROGEN CHIP STANDARDS

<u>PART #</u>	<u>% CARBON</u>	<u>% SULFUR</u>	<u>NITROGEN</u>	<u>WEIGHT</u>
AR946	0.0029	0.0043	0.0019%	150g
AR947	0.389	0.094	121 PPM	150g
AR948	0.506	0.078	0.0090%	150g
AR949	0.0137	0.027	860 PPM	150g
AR950	0.055	0.0103	0.0058%	150g
AR951	0.147	0.027	0.0116%	150g
AR952	0.470	0.021	104 PPM	150g
AR953	0.927	0.011	57 PPM	150g
AR954	0.401	0.0209	0.0067%	150g
AR955	0.204	0.0284	91 PPM	150g
AR956	0.474	0.288	0.0072%	150g
AR957	0.154	0.112	30 PPM	150g
AR958	0.015	0.023	0.068%	150g
AR960	0.133	0.0013	0.035%	150g
AR961	0.022	0.0093	0.041%	150g

CAST IRON THRU WROUGHT IRON STANDARDS

<u>PART #</u>	<u>% CARBON</u>	<u>% SULFUR</u>	<u>WEIGHT</u>
AR299	1.05	0.011	150g
AR300	3.26	0.021	150g
AR301	2.02	0.018	150g
AR302	3.30	0.057	150g
AR303	3.94	0.022	150g
AR304	4.23	0.014	150g
AR305	2.79	0.012	150g
AR306	3.50	0.019	150g
AR309	3.70	0.024	150g
AR310	3.35	0.085	150g
AR315	3.09	0.111	150g
AR318	3.08	0.037	150g
AR319**	3.28	0.055	150g
AR322**	3.41	0.050	250g
AR323**	3.92	0.075	250g
AR673	0.0004	0.0017	454g

Alpha Resources is proud to be ISO 17025 Accredited and Guide 34

Standard are typical. Please contact Alpha Resources or visit our website for current values.

ORE STANDARDS

PART #	WEIGHT	% CARBON	% SULFUR
AR4005	30g	1.42	1.41
AR4006	30g	4.19	4.07
AR4007	30g	7.27	3.26

LIMESTONE STANDARDS

PART #	WEIGHT	% CARBON	% SULFUR
AR4012	25g	11.97	0.044
AR4013	25g	2.93	0.020
AR4014	25g	5.87	0.029
AR4022	25g	7.00	0.145
AR4023	25g	11.70	0.220
AR4024	25g	11.72	0.418

SOIL STANDARDS

PART #	WEIGHT	% CARBON	% SULFUR	% NITROGEN
AR4015	25g	1.18	0.12	N/A
AR4016	25g	2.24	2.08	N/A
AR4017	25g	0.50	0.44	N/A
AR4018	25g	1.30	0.98	N/A
AR4019	25g	0.102	0.100	N/A
AR4025	25g	N/A	N/A	0.460
AR4026	25g	N/A	N/A	1.00
AR4027	25g	N/A	N/A	1.64
AR4028	25g	N/A	N/A	2.02

SYNTHETIC CATALYST STANDARD

PART #	WEIGHT	% CARBON	% SULFUR
KED1022	100g	24.6	11.3
KED1024	100g	14.2	5.7

BORON CARBIDE STANDARD

PART #	WEIGHT	% CARBON
KED1023	100g	21.53

COMPOSITE SOIL STANDARDS

PART #	WEIGHT	% CARBON	% SULFUR
AR4020	100g	0.92	N/A
AR4021	100g	2.73	N/A

OXYGEN IN COPPER PINS

PART #	SIZE	OXYGEN	SULFUR	PCS/BOTTLE
AR147	1g	0.0007%	0.0013%	100
AR148	1g	489 PPM	6 PPM	100
AR149	1g	323 PPM	11 PPM	100

Alpha Resources is proud to be ISO 17025 Accredited and Guide 34

Standard are typical. Please contact Alpha Resources or visit our website for current values.

OXYGEN/NITROGEN IN STEEL PINS

<u>PART #</u>	<u>SIZE</u>	<u>OXYGEN</u>	<u>NITROGEN</u>	<u>PCS/BOTTLE</u>
AR644	1g	3 PPM	157 PPM	100
AR645	1g	0.0050%	0.0058%	100
AR646	1g	40 PPM	670 PPM	100
AR1647	1g	33 PPM	1807 PPM	100
AR1648	1g	0.0148%	0.0065%	100
AR1650	1g	100 PPM	102 PPM	100
AR1651	1g	0.0057%	0.0210%	100
AR1652	1g	0.0037%	0.0540%	100
AR1653	1g	0.0011%	0.0029%	100
AR1656	1g	244 PPM	118 PPM	100
AR654	0.5g	65 PPM	534 PPM	100
AR655	0.5g	0.0021%	0.393%	100
AR656	0.5g	0.0081%	0.0213%	100
AR657	0.5g	0.0109%	0.0102%	100
AR659	0.5g	120 PPM	66 PPM	100
AR660	0.5g	0.0045%	0.0060%	100
AR661	0.5g	0.0006%	0.0166%	100
AR662	0.5g	0.0026%	0.069%	100
AR663	0.5g	0.0032%	0.145%	100
AR668	0.5g	0.0015%	0.0029%	100
AR670	0.5g	255 PPM	123 PPM	100
AR675	0.5g	0.077%	0.248%	100
AR676	0.5g	329 PPM	1214 PPM	100

TITANIUM PINS FOR HYDROGEN, OXYGEN, NITROGEN

<u>PART #</u>	<u>SIZE</u>	<u>OXYGEN</u>	<u>NITROGEN</u>	<u>HYDROGEN</u>	<u>PCS/BOTTLE</u>
AR588	0.25g	-	-	0.0137	100
AR589	0.25g	-	-	0.0192	100
AR637	0.1g	509 PPM	101 PPM	12 PPM	100
AR641	0.1g	0.1910%	0.0354%	0.0039%	100
AR642	0.1g	0.114%	0.0052%	0.0050%	100
AR647	0.1g	0.215%	0.0063%	0.0077%	100
AR648	0.1g	0.132%	0.075%	0.0137%	100
AR649	0.1g	0.104%	0.0064%	0.0192%	100
AR650	0.1g	0.156%	0.0124%	0.0067%	100
AR651	0.1g	1320 PPM	49 PPM	28 PPM	100

HYDROGEN IN STEEL PINS

<u>PART #</u>	<u>SIZE</u>	<u>HYDROGEN</u>	<u>PCS/BOTTLE</u>
AR546	1g	0.83 PPM	100
AR555	1g	0.00024PPM	100
AR556	1g	6.0 PPM	100
AR558	1g	7.3 PPM	100



CS2000

Carbon and Sulfur Analyzer for inorganic and inorganic materials all in one



What our customers say:

“Can’t be happier with the service and equipment we have purchased from Alpha. We are loving the CS2000”

Barry – Virginia – Mining Industry

Another high quality product at an affordable price brought to you by Alpha Resources

• Extremely Reliable	• Extremely Affordable
• Precise and Quick Measurements	• Organic AND Inorganic Material
• Minimal Maintenance Required	• Filters and Reagents Easily Accessed
• Long Term Stability	• Resistance Furnace of up to 1550C
• Resistance and Induction Furnace	• Autoloader Available in two sizes

The CS2000 by ELTRA provides the speed and accuracy required for today's stringent demands. The unit comes complete with computer, monitor, printer and interfaced 4th place balance.

Because of Alpha[®] your old LECO[®] unit may still be worth \$\$\$\$. Call Alpha[®] and see if this is the case for your old unit. Call us toll free and talk to one of our friendly salesmen. Your best option may well be a new Eltra with a supply credit, in any case, only a few minutes is all it will take. (800) 833-3038 Toll Free!

LECO® CS-400/300/200 SERIES

Part No.	LECO® No.	O-Ring Location
AR920	601-920	Combustion Tube
AR058	762-058	Dust Filter
AR5976	765-976	Reagent Tube
AR520	772-520	Reagent Tube/Filter Tube
AR738	772-738	Catalyst Heater Tube/Reagent Tube
AR1424	781-424	Dust Filter Tube

LECO® CS-444/CS-444LS/IR-412/IR-432

Part No.	LECO® No.	O-Ring Location
AR920	601-920	Combustion Tube
AR172	604-172	Dust Filter Assembly
AR058	762-058	Dust Filter Assembly
AR991	771-991	Dust Filter Assembly
AR520	772-520	Reagent Tube/Filter Tube
AR738	772-738	Catalyst Heater Tube/Furnace Assembly
AR320	773-320	Lance Assembly

LECO® CS-600 SERIES

Part No.	LECO® No.	O-Ring Location
AR920	601-920	Combustion tube
AR5976	765-976	Reagent Tube Seal
AR520	772-520	Reagent Tube
AR738	772-738	Catalyst Heater Tube/Assembly Furnace

LECO® CS-844/744 SERIES

Part No.	LECO® No.	O-Ring Location
AR1385	619-591-385	Combustion Tube Upper/Compression Ring
AR520	772-520	Catalyst Tube/Reagent Tube
AR058	762-058	Dust Filter
AR5976	765-976	Catalyst Tube/Reagent Tube
AR489	774-489	Combustion Tube Ring
A8114	778-114	Catalyst Tube

What our customers say.....

Dear Alpha Resources,

"Your combustion tubes were are very uniform in size and posed no problems for any of our machines... we had no failures at all in over a month and your crucibles are working just great. I must Say, Alpha keeps getting better and better.

Jerry
Michiaan – Steel Ind

LECO® DH-103/DH-102

Part No.	LECO® No.	O-Ring Location
AR520	772-520	Catalyst Heater Tube/Reagent Tube
AR738	772-738	Catalyst Heater Tube/Reagent Tube
AR3913	773-913	Lance Tube Assembly
AR8114	778-114	Catalyst Heater Assembly

LECO® DH-603

Part No.	LECO® No.	O-Ring Location
AR802	602-802	Combustion Tube
AR7083	617-083	Catalyst Block
AR5976	765-976	Reagent Tube
AR520	772-520	Reagent Tube/Catalyst Heater Tube
AR3913	773-913	Piercer

LECO® OHN-836 SERIES

Part No.	LECO® No.	O-Ring Location
AR684	601-684	Loading Head Assembly
AR7083	617-083	Catalyst Block
AR058	762-058	Loading Head Assembly
AR5976	765-976	Reagent Tube/OMI Scrubber/Lower Electrode Assembly
AR520	772-520	Catalyst Tube/Reagent Tube/Screen Filter

LECO® RC-612

Part No.	LECO® No.	O-Ring Location
AR442	601-442	Catalyst Block
AR802	608-802	Combustion Tube
AR7083	617-083	Catalyst Block
AR5976	765-976	Reagent Tube
AR520	772-520	Catalyst Heater Tube/Reagent Tube

LECO® RH-402

Part No.	LECO® No.	O-Ring Location
AR357	762-357	Furnace Assembly
AR520	772-520	Reagent Tube
AR738	773-738	Catalyst Heater Tube
AR2910	772-910	Reaction Tube
AR8114	778-114	Catalyst Heater Assembly

LECO® TC-436/TN-414/RO-416/RH-404

Part No.	LECO® No.	O-Ring Location
AR428	760-226	Upper Electrode Assembly
AR407	771-407	Upper Electrode Assembly
AR520	772-520	Reagent Tube
AR738	772-738	Catalyst Heater Tube
AR489	774-489	Upper Electrode Assembly
AR312	775-312	Lower Electrode Assembly
AR8114	778-114	Catalyst Heater Assembly

LECO® TCH-600 SERIES

Part No.	LECO® No.	O-Ring Location
AR803	602-803	Loading Head Assembly
AR7083	617-083	Incoming Scrubber/Catalyst Heater
AR440	617-440	Loading Head Filter Assembly
AR5976	775-976	Incoming Scrubber
AR520	772-520	Reagent Tube
AR3913	773-913	Loading Head/TC Cell
AR432	774-425	Loading Head Assembly
AR8114	778-114	Incoming Scrubber Assembly

ELTRA CS800

Part No.	Eltra No.	O-Ring Location
AR70230	70230	Reagent Tube
AR70210	70210	Catalyst Heater Tube
AR70350	70350	Dust Filter
AR70370	70370	Dust Filter
AR70320	70320	Dust Filter
AR70120	70120	Cleaning Mechanism Rods
AR70380	70380	Combustion Tube
AR70390	70390	Lower Furnace Block

ELTRA OHN2000/ON900/OH900

Part No.	Eltra No.	O-Ring Location
AR70230	70230	Reagent Tube
AR70210	70210	Catalyst Heater Tube
AR70435	70435	Loading Mechanism
AR70430	70430	Loading Mechanism
AR70405	70405	Lower Furnace

AR2000 SAMPLE PIN CUTTER

Quickly yielding up to three pins of either 1g or 1/2g. Determined by the selection of spacers specified by the customer. For sectioning pins from 4mm to 6mm OD. The unit includes 4 spacers and blades of the customer choice. Please specify 50 or 60 hz. 115 or 230 VAC.



Punches for Nitrogen/Oxygen Analysis

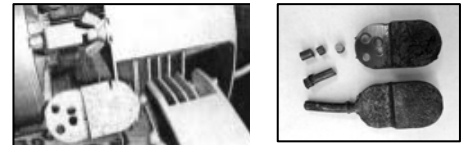

Easily accommodates "Duckbill" or "Lollypop" samplers. The disc portion is quickly sectioned off in cutting pieces while yielding a uniform pins for combustion, fusion or spectrometer analysis. This unit is especially suited for Alpha's Evacuated Pin Tubes

AR2000 (585-600) Sample Pin Cutter 115/200V. 50/60 Hz	AR270 (585-270) Cut Off Wheel ALO2, 7" x 1" x 1/16"	AR200 (585-235) Cut Off Wheel ALO2, 7" x 3/4" x 1/16"	AR5359 Spacer for 1/2 Gram Pin	AR5360 Spacer for 1 Gram Pin
--	--	--	---	---

EVACUATED PIN TUBES

Alpha has improved the design of these tubes. The "bubble" portion is now more uniform and thicker while still keeping the protective entry point. This improvement will give you a more consistent vacuum and is more resistant to breakage. Our new process also allows us to lower the price to you.

Part #	O.D.	I.D.	Length
AR181	5mm	3.5mm	152.4mm
AR182	6mm	4mm	152.4mm
AR183	8mm	6mm	152.4mm

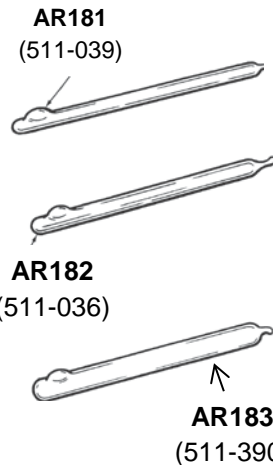
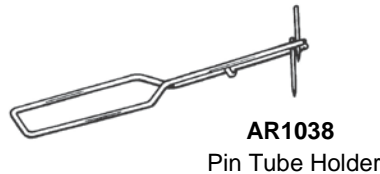

Magnetic Holder



AR5510
Magnetic Holder

This holder was developed to save fingers from grinding and burning, when surfacing samples on a grinding wheel. The 40lb. pull of the magnet, holds the sample. The retaining shield keeps the sample from sliding. A screw is used to break the magnetic field which allows the removal of the sample.



"Alpha Buster" Tool Steel Mortar and Pestle

The mortar measures 76mm x 76mm x 115mm high with a 70mm deep cavity. The pestle is 250mm long

- AR909P** – PESTLE ONLY
- AR909M** – MORTAR ONLY
- AR909** – COMPLETE SET

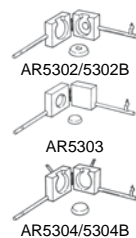

SAMPLE DISC/PIN MOLDS FOR ANALYSIS			
ALPHA NO.	TYPE/SHAPE	DIMENSIONS	USE
AR5302	Vertical Pour (steel) Disc/Recess	0.25" H x 2.5" D Recess .062" Deep 1" D	Aluminum, Lead, Magnesium, Zinc Alloys
AR5302B	Vertical Pour (steel) Disc/No Recess	0.25" H x 2.5" D	Aluminum, Lead, Magnesium, Zinc Alloys
AR5303	Horizontal Pour (steel) Disc/Recess	0.375" H x 1.2" D	Aluminum, Lead, Magnesium, Zinc Alloys
AR5304	Vertical Pour (copper) Air/Water Cooled Pin and Disc	Pin: 1.75" L x 0.187" D Disc: 0.25" H x 1.25" D	Pin suitable for C.H.N.O.S Rapid Chill Discs for Ferrous Base Analysis
AR5304B	Vertical Pour (copper) Air/Water Cooled Pin and Disc	Pin: 1.75" L x 0.187" D Disc: 0.375" H x 1.5" D	Pin suitable for C.H.N.O.S Rapid Chill Discs for Ferrous Base Analysis

Items for LECO®, Eltra, Bruker, and Horiba Carbon and Sulfur Analyzers

Part No.	LECO® No.	Description
AR241	501-241	Vacuum Grease
AR1614	501-614	Spatula
AR022B	760-144	Cleaning Brush
AR901	503-032	Regular Glass Scoop 0.14cc
AR542	767-542	Tungsten Scoop 0.1cc
AR936	762-936	Scoop for V2O5 .6cc
AR579	773-579	Metal Scoop 0.18cc Virtually Indestructible
AR929	761-929	Crucible Tongs
AR110	501-110	Dust Box/Pinch Valve Silicon Tubing
AR484	601-484	Printer Ribbon Cartridge
AR022	501-082	Wire Brush
AR5306	775-306	Secondary Filter

Items for LECO®, Bruker, Eltra, Horiba Oxygen, Hydrogen, Nitrogen Analyzers

Part No.	LECO® No.	Description
AR241	501-241	Vacuum Grease
AR766	766-053	Curved Graphite Crucible Tweezers
AR5933	765-933	Cooling Agent
AR138	760-138	Tweezers
AR980	768-980	Balston Filter

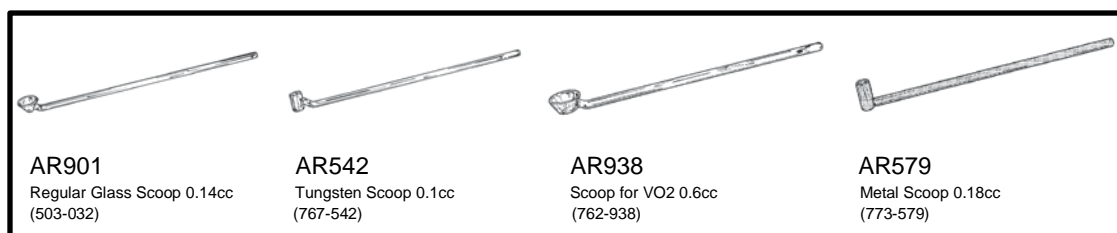

Another useful item from Alpha. This handy tray makes it easy for the operator to weigh his samples prior to analysis and keep them in exact order
AR1265 (501-265)
 Crucible Tray Holder



Refractory plate prevents burned counter tops and eliminates lab fire hazards caused by hot crucibles and boats. Simply set the hot ceramic items on the plate and allow them to cool
AR028 (781-273)
 ALPHA-PLATE

LECO® #	ALPHA#	DESCRIPTION			
			501-083	AR304	DUCTILE IRON STANDARD, 4.23% C
145-601	AR5601	WATER TEMP REGULATOR	501-089	AR507	VALVE ASSEMBLY FOR 516-000
156-002	AR002	"O" RING (UPPER ELECTRODE)	501-095	AR2814	RESIDUAL OIL, 1.0% S
156-004	AR005	TEFLON BACKUP SEAL	501-099	AR2837	LUBE OIL, 4% S
163-012	AR63012	TUBING INSERT	501-101	AR800	ARROWROOT STARCH SOLUTION
170-001	AR0001	SPRING, LOWER ELECTRODE	501-105	AR301	CAST IRON STANDARD, 2.12% C
172-505	AR2505	TEFLON TUBING, 1/4" OD	501-110	AR110	3/8" I.D. SILICONE TUBING
175-573	AR5573	TEAR OFF BLADE	501-110-019	AR110-19	SILICONE RUBBER TUBE, 3/8" X 19"
175-574	AR5574	OPTICAL SWITCH ASSEMBLY	501-112	AR112	1/4" I.D. NEOPRENE TUBING
175-590	AR5590	PUMP REPAIR KIT, SC32/132	501-123	AR307	TUNGSTEN CARBIDE STD, 100G
175-631	AR5631	MOTOR BRUSH FOR 774-571	501-130	AR1710	COAL STANDARD, 4.0% SULFUR
175-632	AR5632	"O" RING, FLOW CONTROLLER	501-141	AR2779	ULTIMATE COAL STANDARD, 50GM
175-659	AR5659	PAPER DEFLECTOR V55147	501-144	AR144	MAGNESIUM OXIDE
175-673	AR5673	PRINT HEAD	501-147	AR148	COPPER PIN STANDARD, 500PPM
175-674	AR5674	TEAR OFF BLADE SPRING	501-148	AR149	COPPER PIN STANDARD, 3000PPM
183-001	AR2174	ALPHASOLVE II, 20 - 30 MESH	501-165	AR1165	DRIERITE INDICATING 10-20M, 454GM
188-012	AR293	SMALL THROAT BRUSH	501-166	AR166	ASCARITE II 8 - 20 MESH
190-142	AR142	SCREWS FOR LOWER ELECTRODE, 4 REQUIRED	501-170	AR170	RARE EARTH COPPER OXIDE
190-739	AR739	NYLON SPACER SCREW	501-171	AR171	ANHYDRONE, 8-20 MESH
194-060	AR4060	HEX JAM NUT FOR AR-5814	501-179	AR079P	ALPHANAL, 16 OZ
204-001	AR001	THERMOREGULATOR TC30,TN14,RO16	501-184	AR1711	COAL STANDARD, 5.0% SULFUR
501-001	AR1701	COAL STANDARD, 0.4% SULFUR	501-197	AR197	TRAP MATERIAL 12GM
501-005	AR1704	COAL STANDARD, 1.0% SULFUR	501-233	AR233	CERAMIC ADHESIVE ALUMINA, 20Z
501-008	AR008	ALPHACEL II TUNGSTEN,2.2 KG	501-234	AR234	OXYGEN SPECIMEN FILE
501-009	AR1009	SPRING CLIP FOR DUST TRAP	501-241	AR241	SILICONE GREASE 5.3 OZ.
501-010	AR010	DUST TRAP COMPLETE	501-263	AR263	COPPER METAL ACCELERATOR, 3 lb (1.36 kg)
501-011	AR011	DUST TRAP BODY INSERT	501-264	AR264	COPPER METAL ACCELERATOR, 0.5 lb (227 g)
501-012	AR011B	DUST TRAP RESERVOIR	501-265	AR1265	CRUCIBLE HOLDER TRAY
501-013	AR013	FILTER CLOTHS, PKG. 10	501-280	AR634	"O" RING
501-014	AR1705	COAL STANDARD, 1.5% SULFUR	501-291	AR291	OXYGEN REGULATOR ASSEMBLY
501-020	AR1708	COAL STANDARD, 3.0% SULFUR	501-369	AR1727	PROX COAL STD. 2.5% S
501-022	AR1709	COAL STANDARD, 3.5% SULFUR	501-426	AR426	COMBUSTION CONTROL, SOLID SAMPLES
501-024	AR322	GREY IRON STANDARD 150GM., 3.35%C, 0.041 %S	501-427	AR427	COMBUSTION CONTROL, LIQUID SAMPLES
501-027	AR204	ASPIRATOR BULB	501-428	AR1721	PROX COAL STD. 0.4% S
501-031	AR031	INDUCTION COIL, HYDROCARBON	501-429	AR1723	PROX COAL STD. 1.0% S
501-034	AR1034	CALCIUM CARBONATE, 12%, 50GM	501-430	AR1724	PROX COAL STD. 1.5% S
501-045	AR1045	ZIRCON CRUCIBLE, CHN 900	501-431	AR1726	PROX COAL STD. 2.0% S
501-046	AR2021	SUCROSE STANDARD, 50G	501-432	AR1728	PROX COAL STD. 3.0% S
501-053	AR1053	ACETANILIDE STANDARD, 10GM	501-433	AR1730	PROX COAL STD. 4.0% S
501-057	AR079G	ALPHANAL, 1 GALLON	501-438	AR734	PROX COAL STD. 0.9% S
501-059	AR059	TIN CAPSULES, 100 btl	501-439	AR000	PARAFIN OIL, 118ML/BTL C, H, N, BTU
501-067	AR067	ROTOMETER BALL ONLY	501-441	AR2021	SUCROSE, 50GM
501-073	AR073	GRAPHITE POWDER (BTL) (100GMS)	501-457	AR400	TIN COATED COPPER, 1.3KG
501-076	AR076	TIN METAL	501-458	AR2822	#2 DIESEL OIL
501-077	AR077	IRON CHIP	501-501	AR870	RING STANDARD, 1# JAR, .031 C
501-078	AR078	IRON POWDER	501-502	AR871	RING STANDARD, 1# JAR, .053% C
501-079	AR079	ALPHANAL WETTING AGENT, 118 mL	501-503	AR872	RING STANDARD, 1# JAR, .185% C
501-081	AR081	GLASS WOOL	501-504	AR873	RING STANDARD, 1# JAR, .468% C
501-082	AR022	BRUSH	501-505	AR874	RING STANDARD, 1# JAR, .723% C

501-506	AR875	RING STANDARD, 1# JAR, .817 %C	502-026	AR2818	RESIDUAL OIL
501-529	AR556	1 GM STEEL BALL, 5.7PPM H2	502-029		CONTACT ALPHA FOR ENTIRE RANGE
501-539	AR930	ACTIVATED CHARCOAL, 454GM	502-030		CONTACT ALPHA FOR ENTIRE RANGE
501-551	AR660	N/O STANDARD, 0.5 G, STEEL, 100 BTL	502-032	AR078	ACCELERATOR, 454G FE POWDER
501-552	AR656	N/O STANDARD, 0.5 G, STEEL, 100 BTL	502-040	AR2166	TIN CAPSULE, 6MM OD, 100/BTL
501-553	AR669	N/O STANDARD, 0.5 G, STEEL, 100 BTL	502-042	AR025	QUARTZ CRUCIBLE, CHN
501-561	AR2016	SOY BEAN MEAL SRM	502-049	AR049	REAGENT "N" CATALYST
501-563	AR2025	CORN MEAL SRM	502-060	AR556	1.0 GM STEEL PIN STD., 5.7PPM HYDROGEN
501-571	AR571	COPPER CAPSULES, 100 BTL	502-061	AR555	1.0GM STEEL PIN STD., 2.5PPM HYDROGEN
501-587	AR912	PLATINIZED SILICA	502-062	AR4020	SOIL STANDARD, 1% C, 100 G
501-592	AR062	MANGANESE DIOXIDE, 250 CC	502-071	AR2864	HIGH SULFUR RESIDUAL OIL, 118ML 30% S
501-598	AR598	NIBBLED NICKEL FLUX, 100GM BTL	502-072	AR655	1/2 GM STEEL PIN, N = 3896 PPM O = 2
501-608	AR1608	QUARTZ WOOL WADDING, 200 GM	502-076	AR571	COPPER CAPSULES, 100/BLT
501-609	AR615	FURNACE REAGENT, 100GM	502-077	AR570	TIN PLUGS, 150/BTL
501-614	AR1614	SPATULA	502-085	AR3085	ZN SULFIDE, 32% S, 50GM
501-621	AR621	COPPER TURNINGS	502-091	AR091	CALCIUM OXALATE STD, 50GM
501-632	AR632	MOLE SIEVE TRAP 14G	502-092	AR2092	EDTA STANDARD, 50GM
501-636	AR636	VANADIUM PENTOXIDE	502-122	AR2122	FIRING FUSE WIRE, 2" PKG OF 10
501-640	AR366	COPPER METAL ACCELERATOR, 25#	502-134	AR2134	BENZOIC ACID TABLET 1.45GM, PK 10
501-641	AR643	COPPER METAL SCRUBBER MATERIAL, 454GM	502-134	AR2134V	BENZOIC ACIT TABLET 1.45GM, PK 500
501-644	AR644	OXYGEN STANDARDS, 1GM STEEL	502-154	AR648	TI PIN STD, 130 PPM HYDROGEN, BTL 100 1/4 G PIINS
501-645	AR1651	N/O STANDARD, 1GM PINS	502-156	AR2156	FLUORHIBIT, 454GM
501-647	AR1655	N/O STANDARD, 1.0 G, STEEL, 100 BTL	502-167	AR2167	TIN CAPSULES, 8MM, 100/BTL, FP428
501-648	AR2776	ULTIMATE COAL STANDARD, 50GM	502-173	AR173	ALPHACEL II - HP, 750G
501-673	AR673	IRON CALIBRATION STANDARD, 454GM	502-174	AR2174	ALPHASOLVE II, CO2 ABSORB 20-30, 500GM
501-674	AR881	PIN STANDARD, .017% C, .003%S	502-176	AR2176	ALPHASOLVE II, CO2 ABSORB 8-20, 500GM
501-675	AR882	PIN STANDARD, .064% C, .021% S	502-177	AR177	FINE QUARTZ WOOL, 50 GM
501-676	AR890	PIN STANDARD, .099% C, .018% S	502-181	AR2181	TUNGSTIC OXIDE, GRANULAR, 60GM
501-677	AR895	PIN STANDARD, .247% C, .021% S	502-183	AR2183	NICKEL CAPSULE, 10.0 mm L X 6.7 mm W, 100/BTL
501-678	AR884	PIN STANDARD, .441% C, .011% S	502-184	AR502	BENZOIC ACID POWDER, 99%, 10 GM
501-679	AR885	PIN STANDARD, .805% C, .022% S	502-186	AR2186	TIN FOIL CUPS, 100/BTL, FP428
501-697	AR612	PLATINIZED CHARCOAL, 50GM	502-187	AR2187	TIN CAPSULE, 3.5mm x 9mm, 100/BTL
501-951	AR1951	NICKEL CALIBRATION WIRE	502-188	AR2188	ALUMINA OXIDE PELLETS, FP428, 200G
501-955	AR1722	PROX COAL STD. .7%S	502-189	AR189	COPPER STICKS, 100GM, FP228/428
501-957	AR1729	PROX COAL STD. 3.5%S	502-190	AEB1002	COPPER OXIDE, FINE WIRES, 100GM
501-959	AR742	PROX COAL STD. 2.0%S	502-203	AEB2031	STEARIC ACID STANDARD, 1GM
501-961	AR304	DUCTILE IRON STANDARD, 4.15%C	502-204	AEB2034	DINITROBENZOIC ACID STANDARD, 1GM
501-964	AR1712	COAL STANDARD, 6.0% SULFUR	502-205	AEB2030	CAFFEINE STANDARD, 1GM
501-967	AR2851	EXTREME PRESSURE OIL	502-206	ASD2003	SILVER CAPSULES, 3.5 X 5 MM, 100PCS
501-968	AR2852	EXTREME PRESSURE OIL	502-207	AEB2035	CYSTINE STANDARD, 1GM
501-969	AR2853	EXTREME PRESSURE OIL	502-208	AEB2036	SULPHANILAMIDE STANDARD, 1GM
502-005	AR1205	PIPETTE BRUSH	502-209	AR2209	SULPHAMETHAZINE STANDARD, 5GM
502-007	AR2189	TUBE CLEANER, 8MM X 4FT, FP428	502-211	AR211	GLYCINE 99%, 50 GM
502-008	AR570	TIN PLUGS, 150/BTL	502-213	AR2213	LEAK DETECTION SOLUTION, 4OZ
502-016	AR655	N/O STANDARD, 0.5G, STEEL, 100 BTL	502-225	AEB1036	SILVER TUNGSTATE/MGO, 100GM
502-020	AR599	ETCHABLE NICKEL FLUX 100GM	502-226	AEB1009	SILVER VANADATE, 10GM
502-021	AR548	HYDROGEN STANDARD, .5PPM H2/100	502-227	ATD1000	TIN CAPSULES, 3.2mm X 4mm, 500
502-023	AR473	REAGENT TUBE FUNNEL	502-231	AR673	HI PURITY IRON STD, LOW C & S
502-024	AR651	0.1GM PINS, 10GM BTL, 29PPM HYDROGEN, TI	502-258	AR621	COPPER TURNINGS, DEGASSED, 200GM

502-266	AR205	FIRING FUSE WIRE, 300 DTMS, 0.006" Dia	502-418	AR2838	SULFUR IN LUBE OIL, 0.05%S, 4 OZ (118ML)
502-272	AR2017	CORN GLUTEN, C,H,N,S, 30G	502-419	AR2934	SULFUR IN LUBE OIL, 0.10%S, 4 OZ (118ML)
502-273	AR2018	ALFALFA, C,H,N,S, 30G	502-420	AR2833	SULFUR IN LUBE OIL, 0.50%S, 4 OZ (118ML)
502-274	AR2019	WHEAT FLOUR, C,H,N,S, 30G	502-421	AR2835	SULFUR IN LUBE OIL, 1.00%S, 4 OZ (118ML)
502-275	AR2020	RYE FLOUR, C,H,N,S, 30G	502-422	AR2836	SULFUR IN LUBE OIL, 2.00%S, 4 OZ (118ML)
502-276	AR2026	OAT MEAL, C,H,N,S, 30G	502-423	AR2837	SULFUR IN LUBE OIL, 4.00%S, 4 OZ (118ML)
502-277	AR2027	BARLEY, C,H,N,S. 30G	502-424	AR2871	SULFUR IN #2 DIESEL FUEL, 0.01%S, 4 OZ (118ML)
502-278	AR2028	RICE FLOUR, C,H,N,S. 30G	502-425	AR2873	SULFUR IN #2 DIESEL FUEL, 0.02%S, 4 OZ (118ML)
502-282	AR189	COPPER STICKS, 100G AMPULE	502-426	AR2875	SULFUR IN #2 DIESEL FUEL, 0.05%S, 4 OZ (118ML)
502-294	AR008F	REPLACED BY AR 008 OR AR 173	502-427	AR2877	SULFUR IN #2 DIESEL FUEL, 0.10%S, 4 OZ (118ML)
502-295	AR621	COPPER TURNINGS, DEGASSED, 200GM	502-428	AR2823	SULFUR IN #2 DIESEL FUEL, 0.50%S, 4 OZ (118ML)
502-297	AR008B	ALPHACEL II, HP, 13.6KG	502-429	AR2825	SULFUR IN #2 DIESEL FUEL, 1.00%S, 4 OZ (118ML)
502-298	AR298	SULFAMETHAZINE, 25 GM	502-430	AR2827	SULFUR IN #2 DIESEL FUEL, 2.00%S, 4 OZ (118ML)
502-301	AR2301	TUNGSTEN OXIDE, 125GM	502-431	AR2829	SULFUR IN #2 DIESEL FUEL, 3.00%S, 4 OZ (118ML)
502-304	AR2304	COPPER STICKS, 100G PACKED IN ARGON AMPOULE	502-433	AR1700	COAL STANDARD, 50 GM, 0.29%S NOM
502-304-500	AR2304500	COPPER STICKS, RESEALABLE BTL, 500 GM	502-434	AR1702	COAL STANDARD, 50 GM, 0.74%S NOM
502-308	AR4016	SOIL STANDARD, 2% C & S, 25 G	502-435	AR1704	COAL STANDARD, 50 GM, 0.95%S NOM
502-310	AR2310	STEEL WOOL FILTER MATERIAL, 454GM	502-436	AR1705	COAL STANDARD, 50 GM, 1.54%S NOM
502-311	AR2311	FURNACE REAGENT 1000, 100GM	502-437	AR1708	COAL STANDARD, 50 GM, 2.93%S NOM
502-314	AR177	QUARTZ WOOL, 28.4GM	502-438	AR1710	COAL STANDARD, 50 GM, 4.95%S NOM
502-318	AR4017	SOIL STANDARD, 25 GMS, C=0.5%, S= 0.5%	502-450	AR450	HEATED PARTICULATE FILTER, PKG OF 50, 3.2MM
502-319	AR4005	ORE STANDARD, 30 GMS, C=1.42%, S=1.41%	502-489	AR2489	POROUS CRUCIBLE CHN, 10 PKG
502-320	AR4006	ORE STANDARD, 30 GMS, C=4.40%, %, S=4.24%	502-493	AR2156	FLUORHIBIT, 454GM
502-321	AR321	ALPHACAT ACCELERATOR, 250 GM	502-820	AR568	NICKEL CAPSULE, 12.3mm L X 6.7mm W, 100 BTL
502-335	AR2335	NICKEL FOIL CRUCIBLE LINERS, PKG 250	502-822	AR568	NICKEL CAPSULE, 12.3 mm L X 6.7mm W, 100 BTL
502-338	AR338	ALPHAGEL CAPSULES, 400 BTL, FOR FP428	503-007	AR007	DETACHABLE FLOAT VALVE
502-343	AR2343	NICKLE BOAT LINER, PKG/100	503-020	AR3020	BORON DISTILLATION APPARATUS
502-344	AR2344	NICKEL BASKETS, LOW OXYGEN, 1G/100BTL	503-031	AR905	FUNNEL (3 LEG)
502-345	AR2345	NICKEL BASKETS, LOW OXYGEN, 1.5G/100BTL	503-032	AR901	SCOOP
502-351	AR351	HALOGEN SCRUBBER, 50 G	503-033	AR033	SULFUR TRAP, FILLED
502-359	AR2359	FURNACE REAGENT, MGO, 200 GM	503-051	AR051	OXYGEN BAFFLE FOR 1 1/8" ID TUBE
502-372	AR4007	ORE STANDARD, 30 GMS, C=7.62%, S=3.25%	503-052	AR052	OXYGEN BAFFLE FOR 1 1/4" ID TUBE
502-374	AR2374	HEATED PARTICULATE FILTER, PKG OF 50, 25MM	507-010	AR911H	CATALYST TUBE (HOPCOLITE)
502-382	AR339	MEDIUM ALPHAGEL CAPS, 400 CAPS PER BTL	507-011	AR911E	CATALYST TUBE (UNFILLED)
502-383	AR1700	COAL STANDARD, 50 GM, 0.27% S NOM	507-012	AR012	REDUCER
502-384	AR1702	COAL STANDARD, 50 GM, 0.74% S NOM	507-100	AR7100	CATALYST FURNACE, REBUILT
502-385	AR1704	COAL STANDARD, 50 GM, 0.95% S NOM	507-200	AR7200	CATALYST FURNACE, REBUILT
502-386	AR1705	COAL STANDARD, 50 GM, 1.54% S NOM	507-207	AR911	CATALYST TUBE, FILLED, PT SI
502-387	AR1708	COAL STANDARD, 50 GM, 2.03% S NOM	507-207	AR911R	CATALYST TUBE, FILLED, RARE EARTH
502-388	AR1711	COAL STANDARD, 50 GM, 2.93% S NOM	508-300	AR8300	CATALYST HEATER, REBUILT
502-389	AR2892	RESIDUAL OIL STANDARD, 0.10%S, 4 OZ (118ML)	508-400	AR8400	CATALYST HEATER, REBUILT
502-390	AR2895	RESIDUAL OIL STANDARD, 0.50%S, 4 OZ (118ML)	508-500	AR8500	CATALYST HEATER, REBUILT
502-391	AR2814	RESIDUAL OIL STANDARD, 1.00%S, 4 OZ (118ML)	508-600	AR8600	CATALYST HEATER, REBUILT
502-392	AR2815	RESIDUAL OIL STANDARD, 2.00%S, 4 OZ (118ML)	511-036	AR182	4MM I.D. EVACUATED PIN TUBE
502-393	AR2816	RESIDUAL OIL STANDARD, 3.00%S, 4 OZ (118ML)	511-038	AR1038	PIN TUBE HOLDER
502-394	AR2899	RESIDUAL OIL STANDARD, 4.5%S, 4 OZ (118ML)	511-039	AR181	3MM I.D. EVACUATED PIN TUBE
502-397	AR2397	LARGE TIN FOIL CUPS, 100 PER BTL	511-390	AR183	6MM I.D. EVACUATED PIN TUBE, PKG 10
502-397-400	AR2397-400	LARGE TIN FOIL CUPS, 400 PER BTL	516-000	AR906	PURIFYING TRAIN
502-417	AR2838	SULFUR IN LUBE OIL 0.01%S, 4 OZ (118ML)	516-004	AR504	ROTOMETER

516-005	AR505	DRYING TOWER	529-203	AR8203P	COMBUSTION BOAT SC32/132/CR12
516-006	AR506	ACID TOWER	529-204	AR9204P	COMBUSTION BOAT, S-144DR, BAG OF 50
516-063	AR507	NEEDLE VALVE COMPLETE	529-204-250	AR9204250	COMBUSTION BOAT, BOX OF 250
517-204	AR204	RUBBER SQUEEZE BULB	532-060	AR045	REBUILT PHOTOCELL ASSEMBLY
518-016	AR016	BURRETTE	532-065	AR065	BURRETTE FOR 532-500
518-024	AR024	LIGHT DIRECTOR	532-066	AR066	VESSEL FOR 532-500
518-030	AR017	VESSEL	532-500	AR532	AUTOMATIC SULFUR TITRATOR
518-045	AR045	REWORKED PHOTOCELL	533-104	AR801	STARCH DISPENSING
519-004	AR004	HYDROCARBON SULFUR TUBE	537-103	AR103	1/4" O.D. POLYFLOW TUBING
519-005	AR900	IGNITOR	540-140	AR140	BULB
519-009	AR009	PEDESTAL	544-147	AR4147	LEVELING BOTTLE FOR 572
521-112	AR114	SILICONE TUBING, 4" X 3/8" I.D.	549-007	AR907	ARMATURE
521-113	AR113	SILICONE RING SEAL	549-072	AR9072	RESTRICTOR
521-186	AR187	SOLID STATE RECTIFIER	549-076	AR176	BULB, LIGHT SOURCE FOR 518, 532
521-287	AR287	SUPPRESSOR COIL	550-004	AR404S	OSCILLATOR TUBE, EIMAC
521-305	AR932	DRYING TUBE	550-007	AR5007	45 SEC TIME DELAY TUBE
528-018	AR3818	CERAMIC CRUCIBLE	550-044	AR044	INSULATOR, PORCELAIN 521/523
528-028	AR8028	FILTERING CRUCIBLES, SMALL	550-046	AR046	RESISTOR, 521/523
528-030	AR8030	FILTERING CRUCIBLES, LARGE	550-047	AR0047	RF CHOKE FOR 521/523
528-040	AR040	COVER, 4MM HOLE	550-048	AR048	RF CHOKE
528-042	AR042	POROUS COVERS	550-053	AR0053	POWER SWITCH FOR 521/523
528-043	AR9880	COVERS W/ 10MM HOLE	550-119	AR019	RIGHT ANGLE BEND
528-050	AR3818B	CERAMIC CRUCIBLES, BAGS/500/BOX	550-120	AR120	SULFUR COMBUSTION TUBE
528-053	AR8053	COMBUSTION BOAT, 4" X 1/2"	550-122	AR122	CARBON COMBUSTION TUBE
528-120	AR8120	LOW SULFUR CRUCIBLE	550-123	AR123	PEDESTAL INSERT
528-203	AR8203	COMBUSTION BOAT FOR SC132/32/CR-12, 500 BOX	550-124	AR124	PEDESTAL, 2.50"
528-203-250	AR8203250	COMBUSTION BOAT FOR SC132/32/CR-12, 250 BOX	550-165	AR165	SPRING CLIP FOR COMBUSTION TUBE
528-230	AR5282	COMBUSTION BOAT, GLAZED FOR LIQUIDS, PKG OF 50	550-167	AR550	FURNACE FAN FOR MODELS 521/523, 115VAC
528-313	AR8313	COMBUSTION TUBE 1 1/8" X 30" OBE	550-182	AR180	OEGC CRUCIBLE
528-314	AR8314	COMBUSTION TUBE 1 1/4" X 30" OBE	550-183	AR179	QUARTZ CRUCIBLE INSERT FOR AR-180
528-331	AR8331	COMBUSTION TUBE 1 1/8" X 27" TE	550-184	AR184	COPPER RINGS
528-332	AR8332	COMBUSTION TUBE 1 1/8" X 30" TE	550-187	AR186	CAPACITOR
528-333	AR8333	COMBUSTION TUBE 1 1/4" X 30" TE	563-035	AR035	HEADER STOPCOCK, 572, 577
529-007	AR529	CERAMIC PEDESTAL, 3.05"	563-037	AR037	REBUILT BURET FOR 577
529-011	AR9011	CERAMIC LINER SC32/132/CR-12	566-008	AR006	INDUCTION COIL
529-012	AR9012	BOAT STOP KIT (2 X AR9012)	568-016	AR428	"O" RING
529-018	AR3203	CERAMIC NOZZLE 320-00203 LECOMELT	572-016	AR72016	CONTROL VALVE FOR 572
529-022	AR9022	BOAT STOP HALF, HONEYCOMB FINE	572-029	AR029	FLOAT VALVE ASSEMBLY
529-026	AR026	CRUCIBLE CHN-600, PKG. 50	572-031	AR2031	SPLASHPROOF DEVICE
529-028	AR9023	BOAT STOP HALF SC132/32	578-672	AR672	"O" RING
529-031	AR9031	CONE SUPPORT D	585-235	AR200	AL203 WHEEL, 7" X 3/4" H X 1/16"
529-042	AR9042	CERAMIC CRUCIBLE, MAC-400/TGA, SMALL (5)	585-270	AR270	AL203 CUT-OFF WHEEL 7 X 1" X 1/16"
529-043	AR9043	CERAMIC COVER, MAC-400/TGA, SMALL (5)	585-359	AR5359	PIN CUTTER SPACER, FOR 1/2 G PIN
529-044	AR9044	CONE SUPPORT I	585-360	AR5360	PIN CUTTER SPACER, FOR 1 G PIN
529-046	AR9046	CERAMIC TUBE TF-10, 1 1/4" X 23" L	585-500	AR2000X	PIN CUTTER, 1 H.P., 230VAC, 50 Hz.
529-047	AR9047	CERAMIC CRUCIBLE, MAC-400 LARGE (5)	585-600	AR2000	PIN CUTTER, 1 H.P., 115VAC, 60 Hz.
529-048	AR9048	CERAMIC COVER, MAC-400 LARGE (5)	589-305	AR9305	1/4" RUBBER SLEEVE
529-054	AR9023	BOAT STOP HALF SC32/132	589-364	AR9364	OVEN FAN, WR12,TC30, DAYTON
529-055	AR026	CRUCIBLE CHN, BAG OF 50	589-551	AR422	"O" RING (AUTO DROP)

589-699	AR699	LANCE SLEEVE,CS44,IR12/32,AR521	603-052	AR63052	URETH TUBING, .061 X .12 OD, ORANGE, PER FT.
589-859	AR859	THERMISTORS, WR-12, 750	603-350	AR350	"O" RING EXTRACTION TOOL
589-887	AR887	"O" RING	603-493	AR3493	"O" RING
589-891	AR9891	TIMER RELAY 750/589	603-706	AR706	PEDESTAL FOR RH402
593-100	AR593	TIMER, SULFUR TITRATOR	603-707	AR707	REACTION TUBE RH402
598-142	AR859	THERMISTORS, WR-12, 750	603-710	AR710	QUARTZ CRUCIBLES, RH402, 24PCS
598-157	AR157	MOISTURE TRAP, FILLED, 750, 598	603-910	AR3910	"O" RING
598-158	AR158	MOISTURE TRAP, UNFILLED, 750, 598	603-970	AR3970	"O" RING RH402, UPPER LOAD MECH
598-257	AR257	REPLACED BY 614-591	603-971	AR3971	"O" RING RH402, UPPER LOAD MECH
598-614	AR613	BULBS - SWITCHES 6.3V (750-100)	604-112	AR604	QUARTZ CATALYST TUBE
601-064	AR064	QUARTZ HEATER TUBE, CF-10	604-114	AR923	PEDESTAL ONLY, QUARTZ WITH FITTING
601-065	AR1065	PYREX REAGENT TUBE, CF-10	604-163	AR163	BRASS BRUSH
601-158	AR1158	"O" RING CHN 800	604-172	AR172	"O" RING
601-159	AR1159	"O" RING CHN 800	604-241	AR4241	REACTION TUBE, HF402/RH402
601-132	AR132	COMBUSTION TUBE CHN 800	604-271	AR271	SS FLUTED BRUSH, DIA SLOTTED
601-133	AR1133	"O" RING (1.0 X 1.25) CHN	604-373	AR4373	CAPSULE HOLDER
601-201	AR1201	REACTION TUBE DH103	604-496	AR4496	TEFLON FLX TUBING .125 X .032W, FT
601-390	AR390	QUICK DISC TUBE FP428	604-518	AR518	SS CLEANING BRUSH, UNSLOTTED
601-397	AR397	SHIM, COMBUSTION TUBE FP428, PK8	604-541	AR4541	LANCE TUBE CHN 900/932
601-437	AR437	QUARTZ CATALYST TUBE, FP428	605-520-087	AR6055	"O" RING PACKAGE,CS200/300/400
601-438	AR438	COMBUSTION TUBE FOR NP228/428, SN 1 THRU 3445	605-814	AR5814	PEDESTAL ADAPTER ASSEMBLY
601-441	AR441	QUARTZ LANCE TUBE, FP428	605-815	AR5815	PEDESTAL ADAPTER, CS144 - CS444
601-442	AR442	"O" RING, FP428, RC612	605-816	AR816	CERAMIC PEDESTAL, CS144-444 SIN
601-482	AR482	HONEYCOMB SUPPORT, FP428	605-817	AR817	PEDESTAL ADAPTER, CS125
601-483	AR483	PRINTER PAPER, 9 1/2 X 11, 600 SHEETS	605-818	AR818	PEDESTAL ADAPTER 606/816, EC12,HF10/20
601-484	AR484	PRINTER RIBBON CARTRIDGE	605-828	AR828	"O" RING, FP428, SN 1 THRU 3445
601-490	AR1490	PELLETIZING FOILER DEVICE	605-830	AR830	"O" RING, CHN
601-504	AR1504	"O" RING, LOADING BLOCK,FP228	605-875	AR5875	FURNACE RED/OX TUBE, CHN900
601-505	AR1505	"O" RING, COMBUSTION TUBE, FP228, RC612	606-026	AR6026	GRAPHITE CRUCIBLE, PKG 10, MICRO OXYGEN
601-506	AR1506	COMBUSTION TUBE, FP228	606-202	AR202	FURNACE FAN FOR FP2000 SERIES
601-654	AR1654	THERMOCOUPLE FOR CHN 2000	606-224	AR6224	THERMOCOUPLE, SC432 SERIES
601-684	AR684	"O" RING, LOADING HEAD ASSEMBLY TC600	606-286	AR563	SHORT STRAP, SC432
601-691	AR1691	.125 CFLEX TUBING, 12"	606-308	AR6308	STEPPED CERAMIC BOAT STOP, SC432
601-691-030	AR169130	CFLEX TUBE, 30"	606-309	AR6309	OUTER COMBUSTION TUBE, SC432
601-691-036	AR169136	CFLEX TUBE, 36"	606-310	AR1477	"O" RING COMB TUBE, SC432
601-862-110	AR1862	FURNACE, FP-428, 550-650 WATTS	606-312	AR1476	"O" RING COMB TUBE, SC432
601-920	AR920	"O" RING	606-313	AR6313	INNER COMBUSTION TUBE, SC432
601-939	AR1939	"O" RING, DOSER, FP428	606-316	AR6316	LANCE TUBE ASSEMBLY, SC432
601-963	AR1963	TIN CAPSULES, 3.5mm X 4mm, CHN932	606-317	AR6317	STAINLESS PURGE TUBE
601-981	AR981	SIDE ARM CLEANING BRUSH, FP428	606-318	AR6318	HEATING ELEMENTS (3), SC432
602-615	AR2615	FURNACE HOUSING W/O END CAPS FP2000	606-319	AR6319	LEAD WIRE BRAIDED 6.5, SC-432
602-802	AR802	"O" RING, RH 402, RC612	606-320	AR6320	BRAID CLAMP FOR SC432 ELEMENT
602-803	AR803	"O" RING, RH 402	606-327	AR6327	GAS DRYING TUBE, SC-432
602-969	AR969	5000 DETERMINATIONS PACKAGE FOR FP-428	606-333	AR6333	"O" RING, LANCE, SC-432
603-047	AR63047	URETH TUBING, .061 X .12 OD, RED, PER FT.	606-340	AR6340	DRILLED LANCE TUBE, FP-2000
603-048	AR63048	URETH TUBING, .061 X .12 OD, BLUE, PER FT.	606-403	AR403	COLLECTION TUBE BRUSH, SC432
603-049	AR63049	URETH TUBING, .061 X .12 OD, GREEN, PER FT.	606-444	AR6644	#2 STEPPED CERAMIC BOAT STOP
603-050	AR63050	URETH TUBING, .061 X .12 OD, BLACK, PER FT.	606-547	AR6547	BOAT PULLER, SC432 AUTOLOADER
603-051	AR63051	URETH TUBING, .061 X .12 OD, WHITE, PER FT.	606-550	AR6550	FINGER ARM FOR AR-6547

606-601	AR6601	HEATING ELEMENTS (4) CS432,CS144	616-108	AR6108	COMBUSTION TUBE, FP528
606-601-100	AR6601100	HEATING ELEMENT KIT	616-138	AR6138	"O" RING, FP-528
606-602	AR6602	FURNACE END CAP, FP-2000	616-139	AR6139	"O" RING, FP-528
606-316	AR6316	LANCE TUBE FOR SC432	616-146	AR6146	LANCE, FP528
606-655	AR6655	GLASS PURIFIER TUBE, SC432	616-504	AR6504	PARTICLE FILTER, FP528
606-747	AR6747	2 HOLE LANCE TUBE, FP-2000, 245MM	616-622	AR6622	MICRO SWITCH CN 2000 SWITCH ONLY, NO LEADS
608-065	AR8065	LANCE TUBE TRUSPEC MICRO OXYGEN	616-632	AR6632	LANCE, SC-432 & FP-2000, 253 mm
608-339	AR8339	COMB TUBE, OLD STYLE, CHN1000 14MM OD X 200MM	616-635	AR394	HEAT SHIELD FOR FP/NS2000, REPLACES 609-394
608-342	AR342	COMBUSTION TUBE, QUARTZ, CHN1000	617-083	AR7083	"O" RING, IN SCRUBBER CAT HEATER
608-343	AR8343	FURNACE ELEMENT, CHN1000	617-136	AR7136	"O" RING, LOADING HEAD, TRUSPEC
608-344	AR344	COMBUSTION TUBE, OUTER, CHN1000	617-440	AR440	"O" RING, FILTER ASSMBY TC600
608-378	AR1476	"O" RING, CHN 1000	617-441	AR7441	MICOR SCREEN FILTER, TCH600
608-379	AR8379	QUARTZ WOOL STRIPS, 15", PKG 10	617-486	AR7486	FITTING REMOVAL TOOL
608-505	AR8505	COMBUSTION TUBE, CERAMIC, CHN1000	617-548	AR7548	FILTER TUBE, TC500, RC612
608-866	AR866	CFLEX TUBING .187" PER FOOT	617-605	AR7605	LARGE CRUCIBLE FOR LIQUIDS, PKG 10
609-114	AR9114	"O" RING, SIDE ARM, SN 3446 UP	617-716	AR7716	QUARTZ FILTER TUBE, TC500
609-116	AR9116	COMBUSTION TUBE, FP428, SN 3446 UP	618-376	AR376	ELECTRODE INSERT
609-129	AR9129	LANCE, STRAIGHT	618-482	AR691	ELECTRODE INSERT
609-170	AR9170	QUICK CAP KIT	618-603	AR603	CATALYST TUBE, 13.0"
609-171	AR9171	PLUNGER FOR CELLULOSIC TUBES	618-657	AR6186	FTG ADAPTER, RC612
609-172	AR9172	TUBING CELLULOSIC, .210ID, 20/PK	618-809	AR8809	REAGENT TUBE, TC600
609-271	AR9271	RADIAL SHAFT SEAL, FP2000 AUTOLOADER	619-065	AR9065	U-SHAPED COMBUSTION TUBE FOR TRUSPEC
609-394	AR394	HEAT SHIELD FOR FP/NS2000	619-154	AR9154	CATALYST HEATER TUBE FOR TRUSPEC
609-474	AR9474	FINGER ARM FOR AR-1207 SHAFT	619-192	AR9192	"O" RING, BOTTOM LOAND HEAD, TRUSPEC
609-728	AR9728	SHAFT SLEEVE BEARING, FP2000 AUTOLOADER	619-233	AR9233	THERMOCOUPLE FOR TRUSPEC TYPE K
610-735	AR735	FURNACE BRUSH, CS-444, DIA SLOTTED	619-268	AR9268	HIGH SENSITIVITY REAGENT TUBE FOR TRUSPEC
611-207	AR1207	PULLER SHAFT ASSEMBLY WITH FINGER	619-316	AR9316	LARGE VOLUME REAGENT TUBE FOR TRUSPEC
611-255	AR9171	PLUNGER ASSEMBLY	619-425	AR9425	STRAIGHT REAGENT TUBE, TRUSPEC
611-351-181	AR691	ELECTRODE INSERT	619-455	AR9455	LARGE REAGENT TUBE
611-351-182	AR691	ELECTRODE INSERT	619-566	AR9566	BRAIDED FURNACE STRAP, PKG 5
611-351-223	AR1351	COMBUSTION TUBE, HD	619-590-409	AR0409	INCOMING CATALYST TUBE (QUARTZ)
611-431	AR1431	"O" RING, 132	619-590-412	AR0412	MEASURE CATALYST TUBE (QUARTZ)
611-476	AR1476	"O" RING, INNER COMBUSTION TUBE	619-590-861	AR861	O RING CS744/CS844
611-477	AR1477	"O" RING, OUTER COMBUSTION TUBE	619-591-314	AR1314	INCOMING REAGENT TUBE (GLASS)
611-790	AR790	"O" RING	619-591-315	AR1315	FURNACE REAGENT TUBE (GLASS)
612-340	AR2340	"O" RING, THERMISTOR BLOCK, TRUSPEC	619-591-385	AR1385	"O" RING, COMBUSTION TUBE CS844
613-563	AR563	SHORT STRAP, SC432 PKG 5	619-591-683	AR683	COMBUSTION TUBE (requires kit AR683K)
614-591	AR257	CABINET FAN, 110V	619-591-699	AR1699	PARTICLE FILTER
614-822-101	AR4101	SMALL BOAT LOOP	619-591-740	AR1740	MEASURE REAGENT TUBE (GLASS)
614-822-102	AR4181	NICKEL BOAT, SMALL FOR AMA 254 Hg	619-591-970	AR1970	SLOTTED SS CLEANING BRUSH
614-822-113	AR4113	LARGE BOAT LOOP	619-774	AR9774	LANCE, TRUSPEC CHNS MICRO
614-822-114	AR4114	NICKEL BOAT, LARGE FOR AMA 254 Hg	619-776	AR9776	REAGENT TUBE CHNS TRUSPEC
614-961	AR4961	CRUCIBLE, FP528, TRUSPEC, PKG 10	619-777	AR9777	DIRECTING MIDDLE TUBE, CHN TRUSPEC
614-962	AR4962	LANCE, FP528	619-803	AR3302	UPPER ELECTRODE BRUSH, 21 MM DIA
616-063	AR6063	BOAT PULLER, SULFUR/CARBON	619-880	AR9880	10 mm HOLE COVER, BOX OF 1000
616-068	AR6068	"O" RING, INNER COMBUSTION TUBE S/SC144	619-880-100	AR09880-100	10 mm HOLE COVER, PKG OF 100
616-070	AR6070	INNER COMBUSTION TUBE S/SC-144	619-895	AR619	GRAPHITE CRUCIBLE, RHN600, PKG OF 1000
616-086	AR6086	STEPPED BOAT STOP, S/SC-144	619-895-100	AR619-100	GRAPHITE CRUCIBLE, RHN600, PKG OF 100
616-089	AR6089	OUTER COMBUSTION TUBE, S/SC-144	620-814	AR691	ELECTRODE INSERT

621-331	AR9047	TGA CRUCIBLE, PKG OF 5	761-376	AR3931	ELECTRODE REPAIR SERVICE
622-001-026	AR026	REAGENT TUBE CHN628	761-383	AR293H	SMALL BRUSH HANDLE ONLY
625-067	AR5067	HEATING ELEMENTS, PKG 6	761-492	AR492	"O" RING, FP428
625-068	AR25068	ELEMENT CLIPS, PKG 12	761-618	AR618	TRAP REPAIR CHARGE/WR-12
625-401-317	AR1317	PURGE TUBE, TRUSPEC, S.S. 97 MM, 3 HOLES	761-651	AR1609	"O" RING, LANCE, FP/CHN
625-401-351	AR6254	LANCE TUBE, SC623 W/AUTOLOADER	761-739	AR639	TIN PELLETS
625-401-352	AR1352	LANCE TUBE, TRUSPEC 225 MM	761-747	AR611	SCHUTZE'S REAGENT, 100GM
625-501	AR6255	THERMOCOUPLE, RC 612	761-918	AR918	"O" RING
625-501-358	AR1358	THERMOCOUPLE SC632	761-929	AR929	CRUCIBLE TONGS FOR AR-3818
625-505-125	AR5125	CATALYST HEATER TUBE RC612	762-023	AR023	NUT ADAPTOR SEAL FOR CS44/IR12
625-505-138	AR5138	HEATING ELEMENT ASSMBY RC612	762-056	AR056	COMBUSTION TUBE
625-505-271	AR5271	KNURLED ADAPTER, RC612	762-057	AR416	"O" RING (DUST FILTER)
625-505-168	AR5168	COMBUSTION TUBE, RC612	762-058	AR058	"O" RING
625-510-402	AR5104	COMBUSTION TUBE, RC612	762-059	AR614	"O" RING (CUP ASSEMBLY)
625-511-154	AR511154	LOWER CRUCIBLE, CHN 5/PACKAGE	762-060	AR417	"O" RING BACKUP
625-601-554	AR1554	COMBUSTION TUBE, TRUMAC	762-062	AR913	OXYGEN LANCE
625-601-555	AR1555	INNER COMBUSTION TUBE, TRUMAC	762-066	AR7620	H V RECTIFIER, 8 KV 1 AMP
625-602-187	AR602	CERAMIC LANCE TUBE, 4 HOLES TRUMAC 291.5MM	762-192	AR192	IR SO2 CELL, CS44/IR32/33
625-710-392	AR0392	REAGENT TUBE OHN836	762-357	AR357	"O" RING (UPPER ADAPTER)
625-711-116	AR1116	REAGENT TUBE OHN836	762-501	AR2501	HANDLE FOR REBUILT 521
625-711-117	AR1117	REAGENT TUBE OHN826	762-523	AR523	OVEN FAN REPLACES HOWARD FAN
660-010-130	AR9233	THERMOCOUPLE FOR TRUSPEC TYPE K	762-621	AR2621	IR CO2 CELL, CS44/IR12
701-030	APT1030	TORCH ASSEMBLY, ICP-2000 LECO	762-627	AR2627	BISCUIT FAN, CS44
702-557	AR2557	"O" RING, TRUSPEC	762-695	AR695	TIN METAL
750-301	AR933	DRYING TUVE, 9.0"	762-697	AR697	LARGE THROAT BRUSH
751-300	AR1300	ELECTRONIC BALANCE, 4TH PLACE	762-741	AR 650	HYDROGEN STANDARD, 1/4 G X 25G
760-034	AR034	GRAPHITE CRUCIBLES	762-747	AR546	HYDROGEN STANDARD, 1 .1 PPM H2/100
760-072	AR072	28 VDC BULBS	762-823	AR697H	BRUSH WITH HANDLE
760-138	AR138	TWEEZERS, STRAIGHT	762-936	AR936	GLASS SCOOP FOR V205, EXTRA LARGE
760-139	AR766	TWEEZERS, CURVED DELUX	763-026	AR027B	ALPHACEL III TUNGSTEN 30# - 20 + 40
760-144	AR022B	BRUSH, 90° BEND	763-027	AR266B	ALPHACEL TUNGSTEN 30# - 12 + 20
760-145	AR0145	POWDER FUNNEL FOR GRAPHITE CRUCIBLES	763-028-500	AR027V	ALPHACEL III, TUNGSTEN, 227.27KG
760-193	AR193	METAL SCREEN	763-029	AR509	NICKEL BASKETS, 1.5 GM
760-224	AR224	"O" RING	763-065	AR508	NICKEL BASKETS, 1.0 GM
760-225	AR425	"O" RING (LOADING HEAD PLUNGER)	763-191	AR103	TUBING POLYFLO, 1/4" O.D.
760-226	AR428	"O" RING	763-213	AR213	GRAPHITE CRUCIBLE FOR RH-1 E
760-293	AR293	BRUSH, CLEANING, SMALL	763-261	AR261	FILTER PAPER, GLASS TUBE
760-304	AR0304	TEFLON WASHER	763-263	AR266	ALPHACEL 5# - 12 + 20
760-316	AR316	WASHER	763-265	AR265	GLASS WOOL, 227GM .
760-317	AR317	GLASS TUBE, 6.64"	763-266	AR027	ALPHACEL TUNGSTEN, - 20 + 40
760-333	AR333	DRYING TUBE, 8"	763-295	AR295	THERMOSTAT, UPPER ELECTRODE
760-335	AR424	"O" RING	763-379	AR3379	"O" RING, FP428
760-359	AR359	"O" RING (QUICK DISCONNECT)	763-467	AR467	IRON CHIP, 25#
760-414	AR414	GRAPHITE CRUCIBLES	763-873	AR3873	ISOLATION BOX BULB, 28VDC
760-841	AR194	"O" RING	763-930	AR930	ACTIVATED CHARCOAL, 454G
761-047	AR047	3" DRYING TUBE	764-015	AR015	BULB FOR 532-500, 28VDC
761-133	AR133	DRYING TUBE, 17.125"	764-078	AR4078	1 GRAM CALIBRATION WEIGHT
761-190	AR190	DRYING TUBE, 11.75"	764-098	AR098	CELLULOSE MATERIAL, 454GM
761-375	AR3931	ELECTRODE REPAIR SERVICE	764-216	AR4216	HELIUM REGULATOR ASSEMBLY

764-242	AR242	TIN FLUX, 454GM BTL	769-520	AR9520	GRAPHITE CRUCIBLES/RH-2
764-330	AR331S	GRAPHITE CRUCIBLE, RH1-EN	769-608	AR608	HALOGEN TRAP MATERIAL, 200GM
764-490	AR490	PEDESTAL, 2-3/4"	769-610	AR610	HALOGEN TRAP MATERIAL, 225GM
764-502	AR4544	ROTRON FURNACE FAN	769-743	AR3931	ELECTRODE REPAIR SERVICE
764-545	AR2832	LUBE OIL, 4 OZ, 0.25% SULFUR	769-761	AR761	CRUCIBLES, RH-3, PKG. 100
764-546	AR2835	LUBE OIL, 4 OZ., 1.00% SULFUR	769-802	AR3931	ELECTRODE REPAIR SERVICE
764-547	AR2836	LUBE OIL, 4 OZ., 2.00% SULFUR	769-821	AR9821	MOLECULAR SIEVE FOR RH-2
764-640	AR334	100 PF CAPACITOR	769-897	AR897	GRAPHITE PEDESTAL RH-2 & RH-3
764-641	AR335	200 PF CAPACITOR	769-898	AR898	LOWER PEDESTAL
764-720	AR064	QUARTZ DISCONNECT TUBE, CF-10	769-994	AR994	GRAPHITE CRUCIBLE FOR RH-1
764-775	AR775	WR-12 TRAP MATERIAL	770-247	AR247	FILTER FOR SC32/132, PKG 4
765-068	AR5068	IR OXYGEN CELL FOR RO17	770-436	AR523	OVEN FAN WITH ADAPTER
765-523	AR523	OVEN FAN, HOWARD KIT	770-718	AR0718	PRINTER
765-624	AR624	TEFLON TUBING, 1/4" O.D./FT.	770-764	AR764	PRINTER PAPER
765-717	AR917	OXYGEN LANCE (WR 12)	770-778	AR778	RIBBON SPOOL ASSEMBLY
765-746	AR746	ROTOMETER, WR12	770-779	AR7707	PRINT HEAD WITH CABLE
765-818	AR5818	OPTIC ISOLATION CABLE	771-015	AR1015	MANUAL WT COMP CONTROL CS46
765-933	AR5933	LUBRICOL COOLING AGENT	771-030	AR030	BUBBLE TUBE
765-976	AR5976	"O" RING, AC AC100, FP428	771-040	AR3913	"O" RING
766-036	AR6036	PNEUMATIC (AIR) REGULATOR ASSEMBLY	771-275	AR1275	PNEUMATIC CYLINDER, CS46/IR112
766-053	AR766	DELUXE CRUCIBLE TWEEZERS, CURVED	771-354	AR354	OSCILLATOR TUBE CS-144-444
766-363	AR363	GRAPHITE CRUCIBLES	771-367	AR1367	QUARTZ CRUCIBLES, DC12, PKG 50
766-557	AR6557	"O" RING	771-373	AR373	DRYING TUBE
766-646	AR6646	AIR FILTER COATING	771-401	AR401	REACTION TUBE FOR RH-2
766-823	AR823	MALE CLIPLOCK FITTING	771-407	AR407	"O" RING
767-243	AR243	FEMALE CLIPLOCK FITTING	771-425	AR1425	POWER TRIODE RH-2, 7.5V
767-277	AR277	GRAPHITE CRUCIBLES	771-446	AR429	"O" RING
767-385	AR085	QUARTZ WOOL, COARSE, 28.4GM	771-606	AR606	PEDESTAL CS-46 & EC-12
767-500	AR914	LANCE, IR33	771-883	AR083	BUBBLE TUBE (EC 12)
767-518	AR7518	RETAINING WIRE CLIP SPRING	771-991	AR991	"O" RING O28
767-541	AR541	DRYING TUBE	772-005	AR760	CHART PAPER ROLL, RH2/3
767-542	AR542	SCOOP FOR TUNGSTEN, 0.01cc, SMALL	772-269	AR269	"O" RING
767-543	AR3931	ELECTRODE REPAIR SERVICE	772-381	AR2381	LANCE CLEANING WIRE
767-544	AR3931	ELECTRODE REPAIR SERVICE	772-402	AR2402	LANCE SC-32/132/CR-12
767-545	AR3931	ELECTRODE REPAIR SERVICE	772-403	AR6403	DRILLED LANCE TUBE, SC432
767-546	AR3931	ELECTRODE REPAIR SERVICE	772-446	AR446	GLASS VIEWING SHIELD, SC32/132
767-547	AR3931	ELECTRODE REPAIR SERVICE	772-449	AR449	ROD, EXTENSION, GLASS SHIELD
767-548	AR3931	ELECTRODE REPAIR SERVICE	772-456	AR456	FLOW CONTROLLER ASSY, REPAIR
767-549	AR3931	ELECTRODE REPAIR SERVICE	772-457	AR456	FLOW CONTROLLER W/O CARD, REPAIR
767-757	AR1706	COAL STANDARD, 2.0% SULFUR	772-460	AR2460	PRESSURE SENSOR
767-758	AR1707	COAL STANDARD, 2.5% SULFUR	772-469	AR469	REPLACED BY 781-165 (AR-469)
767-759	AR720	COKE STANDARD, 0.85% SULFUR	772-508	AR962	ELEMENT FOR SC32/132/CR12
767-838	AR838	"O" RING	772-520	AR520	"O" RING SC32, CS244, 344, RC612
768-774	AR043S	COVERS, PKG.OF 50-SAME AS AR-O43	772-522	AR7073	THERMOCOUPLE ONLY
768-798	AR8798	CLEAN OUT PLUG FOR SC32/132/CR	772-560	AR2560	CHOPPER MOTOR
768-944	AR944	"O" RING	772-568	AR233Q	CERAMIC ADHESIVE ALUMINA, 32OZ
768-980	AR980	PARTICLE FILTER - SC-32/132/RC612	772-738	AR738	"O" RING
769-335	AR469	SS RELAY, HF10, 44F 6848 240 D45	772-739	AR544	CATALYST TUBE (10.75")
769-473	AR3931	ELECTRODE REPAIR SERVICE	772-747	AR2747	FAN FOR CS244

772-795	AR795	OVEN FAN, CS244 & TC136	775-314	AR314	"O" RING, PISTON BLOCK
772-905	AR057	COMBUSTION TUBE, CS 144-444	775-330	AR5330	FOUR WAY VALVE
772-906	AR2906	COMBUSTION TUBE RING HOLDER	775-355	AR355	CATALYST TUBE, 10.75"
772-910	AR2910	"O" RING, PISTON SEAL, FP228	775-416	AR293	CLEANING BRUSH, TC-136, TN-14
773-066	AR3066	STAND OFF INSULATOR	775-416	AR293H	BRUSH HANDLE
773-076	AR3076	INDUCTION COIL, CS46/HF-768	775-431	AR431	INNER GRAPHITE CRUCIBLE 1000/PK
773-106	AR106	DELIVERY TUBE	775-433	AR433	OUTER GRAPHITE CRUCIBLE 50/PK
773-136	AR3136	FITTING, SS FOR FP428	775-446	AR5446	NEW UPPER ELECTRODE
773-140	AR3140	INNER METAL FILTER, CS-46	775-446	AR3930	ELECTRODE INSERT REPAIR SERVICE
773-141	AR320	"O" RING	775-601	AR601	BUBBLE TUBE, LEFT
773-311	AR311	SST FILTER	775-625	AR625	MOMENTARY PUSH SWITCH
773-314	AR3314	UNFLUTED CLEANING BRUSH	775-677	AR677	"O" RING
773-316	AR789	LANCE TUBE,CS125	775-722	AR456	FLOW CONTROLLER, REPAIR SERVICE
773-320	AR320	"O" RING	775-814	AR402	REACTION TUBE, THICK WALL, RH2/3
773-561	AR561	SS CLEANING BRUSH, STRAIGHT SLOTTED	775-859	AR5859	WIRE CLEANING BRUSH, SC32/132
773-579	AR579	METAL SCOOP	775-880	AR880	QUICK DISCO TUBE, 4", STRAIGHT, FP228
773-662	AR3662	POLYFLO FLEX TUBING, CHN	775-892	AR431P	INNER GRAPHITE CRUCIBLE, PKG 100
773-913	AR3913	"O" RING	776-017	AR6017	"O" RING, BALLAST PLATE, TRUSPEC
773-928	AR3928	DELIVERY TUBE FOR SC32/132	776-095	AR095	SILICONE TUBING DUST COLL.
773-931	AR9931	TEFLON DISCONNECT BLOCK, SC132	776-129	AR129	INDUCTION COIL, CS-144-444
773-932	AR3932	COMBUSTION TUBE REPAIR SERVICE	776-234	AR6234	10 MICRON FILTER, 1GPM
774-031	AR4031	QUICK DISCON TUBE 1.38" OD	776-247	AR053	GRAPHITE CRUCIBLES
774-174	AR4174	PURGE TUBE	776-265	AR6265	ADJUSTABLE PEDESTAL ASSBLY, 923/4060/6922
774-204	AR4204	AC CRUCIBLES, SST, PKG OF 10	776-279	AR279	CATALYST HEATER TUBE
774-205	AR205	FUSE WIRE, 300 DETERMINATIONS, 0.006" DIA	776-283	AR283	QUARTZ LANCE CHN-600/800
774-208	AR208	BENZOIC ACID TABLETS, VIAL OF 10	776-284	AR284	"O" RING, COMB TUBE FP228
774-211	AR4211	"O" RING, 2.6 X 2.875	776-286	AR286	COMBUSTION TUBE CHN 600
774-253	AR4253	"O" RING	776-685	AR6685	TYNA-MITE SOLENOID
774-283	AR4283	"O" RING	776-922	AR6922	SHIELD & COLLAR FOR PEDESTAL
774-425	AR432	"O" RING, CLOSURE BLOCK	776-923	AR923	QUARTZ PEDESTAL POST CS144-444
774-460	AR460	THERMOCOUPLE ASSY SC32/132/CR12	776-931	AR606	PEDESTAL HF10/20
774-489	AR489	"O" RING, UPPER ELECTRODE	776-962	AR962	ELEMENT FOR SC32/132/CR12
774-570	AR4570	VACUUM PUMP FOR EARLY SC32 110VAC	776-978	AR978	GLASS SCOOP, MAC 400
774-571	AR4571	VACUUM PUMP FOR SC32/132,24VDC	777-060	AR7060	QUARTZ COMBUSTION TUBE, SC32/132
774-613	AR4613	"O" RING, HF400 PINCH VALVE	777-064	AR928	PYREX DELIVERY TUBE FOR AR-7060
774-638	AR638	DISCO TUBE, 6" STRAIGHT, RO116	777-066	AR7066	QUARTZ LINER FOR AR-7060
774-649	AR653	CLEANING BRUSH WITH HANDLE	777-073	AR7073	THERMOCOUPLE
774-651	AR652	BRUSH HANDLE ONLY	778-114	AR8114	"O" RING 111
774-652	AR652	BRUSH FOR TC-136	778-116	AR8116	"O" RING 256, BALLAST, FP228
774-690	AR690	KNURLED RING COLLAR,EF100/EF500	778-120	AR781	NEOPRENE GASKET, BALLAST, FP228
774-691	AR691	REPLACED BY 618-482	778-379	AR8380	COMBUSTION TUBE INSULATOR, FP528
774-692	AR692	LOWER ELECTRODE EXCHANGE/REPAIR ONLY	778-492	AR456	FLOW CONTROLLER, REPAIR SERVICE
774-693	AR693	LOWER ELECTRODE PLATE, REPAIR ONLY AUTOLOAD	778-596	AR596	SST FILTER
774-809	AR809	INDUCTION COIL HF10, S/OIL	778-674	AR674	GRAPHITE CRUCIBLE, 2GM
774-841	AR841	THERMISTOR SENSOR, LOWER DRAIN	778-891	AR8891	CRUCIBLE, QUARTZ, LARGE, EA
775-288	AR3403	BENZOIC ACID POWDER, 454 GM	778-892	AR8892	COVER, QUARTZ, LARGE, EA
775-306	AR5306	SECONDARY FILTER	780-044	AR609	ASSY SAMPLE PULLER
775-312	AR312	"O" RING, LOWER ELECTRODE	780-047	AR1202	REACTION TUBE FOR DH102
775-313	AR313	TEFLON BACKUP RING	780-093	AR093	QUARTZ CRUCIBLE, MAC 400

780-094	AR094	QUARTZ CRUCIBLE COVER, MAC 400	783-189	AR3189	"O" RING, CHN1000
780-379	AR379	QUARTZ WINDOW	783-190	AR3897	"O" RING, CHN1000 REPLACED BY 783-897
780-831	AR831	"O" RING, CHN 1000 LANCE	783-193	AR8343	CHN-1000 FURNACE ELEMENT WITH INSULATION
780-853	AR853	THERMISTOR, LEVEL	783-274	AR278	LANCE ONLY WITHOUT METAL RING
780-890	AR7808	LARGE GRAPHITE CRUCIBLE, 1000/pkg	783-278	AR278	FURNACE LANCE, CHN1000
780-892	AR0892	GRAPHITE COVERS FOR AR-7808, 1000/pkg	783-299	AR2038	COMBUSTION TUBE FOR RC-412
780-899	AR899	HONEYCOMB SUPPORT, 1.25W X 1.5L FP	783-301	AR3301	BRUSH END, .38DIA.
780-911	AR910	CATALYST HEATER TUBE	783-302	AR3302	BRUSH END MODIFIED
780-927	AR927	PRINTER PAPER ROLL	783-515	AR515	"O" RING
780-928	AR926	PRINTER RIBBON	783-897	AR3897	"O" RING, CH1000
780-953	AR922	PEDESTAL CS-125	789-094	AR618	TRAP ASSEMBLY, MOL SIEVE, WR-12/112
781-098	AR1098	THERMISTOR, HIGH WATER	789-114	AR6317	STAINLESS PURGE TUBE FOR SC432
781-101	AR101	THERMISTOR, LOW WATER	789-115	AR789	LANCE TUBE ASSMBY, CS225, WO/AUTOCLNR 4.28"
781-165	AR469	SS RELAY TC136 44F 6848 240 D45	789-116	AR4174	PURGE TUBE, SC32/132
781-273	AR028	CERAMIC CRUCIBLE TRAY	789-118	AR9118	LANCE TUBE ASSY, 5.12LG,CS225
781-335	AR1335	QUARTZ BOAT FOR RC-412, RC612	789-122	AR2601	VACUUM CLEANER, SPECIFY 110/220 VAC
781-371	AR371	FAN FOR CS244, 240V, 50/60Hz	789-412	AR9412	CATALYST TUBE 10.75 INCH
781-424	AR1424	"O" RING	874-000-181	AR4181	NICKEL BOAT, SMALL FOR LECO AMA 254 Hg
781-585	AR1585	OVER TEMP THERMOCOUPLE, RC612			
781-671	AR671	INK JET PRINTER PAPER			
781-698	AR1698	CATALYST TUBE RH402,QUARTZ,10.75"			
781-883	AR1883	INK JET PAPER 500			
781-902	AR902	INK JET CARTRIDGE			
782-004	AR928	DELIVERY TUBE SC132/32/CR-12			
782-010	AR7060	QUARTZ COMBUSTION TUBE			
782-038	AR2038	COMBUSTION TUBE FOR RC-412			
782-059	AR2059	NICKEL BOAT LINERS, PKG/10 FOR AR1335			
782-079-110	AR9023	CERAMIC BOAT STOP, HI FLOW			
782-079-115	AR9110	CERAMIC BOAT STOP, MEDIUM FLOW			
782-079-120	AR9022	CERAMIC BOAT STOP, LOW FLOW			
782-338	AR2338	MOISTURE REMOVAL TUBE, INDICATING			
782-428	AR2428	QUARTZ CATALYST TUBE, RC-412			
782-534	AR3930	ELECTRODE INSERT REPAIR SERVICE			
782-601	AR2601	VACUUM CLEANER			
782-703	AR7203	HI PURITY OUTER GRAPHITE CRUCIBLE 1000/pkg			
782-703-100	AR2703P	HI PURITY OUTER GRAPHITE CRUCIBLE 100/pkg			
782-719	AR782P	HI TEMP GRAPHITE CRUCIBLE, 200/pkg			
782-720	AR7827	HI TEMP GRAPHITE CRUCIBLE, BOX OF 1000			
782-720S	AR720S	GRAPHITE HI-DENSITY HI-TEMP CRUCIBLE			
782-720SHD	AR782HD	GRAPHITE HI-DENSITY HI-TEMP CRUCIBLE			
782-721	AR721	HI-TEMP ELECTRODE INSERT			
782-795HD	AR2795	INNER CRUCIBLE FOR AR-2703, 1000/pkg			
782-835	AR3930	ELECTRODE INSERT REPAIR SERVICE			
782-877	AR877	TRIM STEP BRUSH FOR 782-918			
782-880	AR2880	VACUUM FILTER FOR CS444			
782-918	AR877H	HANDLE ONLY FOR AR-877			
782-938	AR938	COMPOSITE BRUSH FOR 782-942			
782-942	AR938H	HANDLE ONLY FOR AR-938			
783-177	AR962	HEATING ELEMENT FOR SC32/132, CR12			

Alpha Products for Metallography

Alpha offers a complete line of products for metallography. No major supplier of metallographic equipment and supplies makes any of their own abrasives, diamond or mounting compounds, polishing cloths or much else of the other over-priced items they supply under their fancy labels. Alpha offers you a quality line of products from a select number of proven suppliers. All at **AFFORDABLE** prices



METALS

HORIBA

Crude Oil

SPECTRO
Coke

*Titanium
Pins*

elementar

BAIRD

COAL

FISONS

ARL STANDARDS

Supplies

**Plant
Tissue**

PERKIN ELMER

ASOMA

COAL *Chlorine*

Petroleum

CHN/O/S

ICP

**Elemental
Analysis**

LECO®